

# SHARP®

Carousel™



## CONVECTION MICROWAVE OVEN

**MODELS** R-980J  
R-990J(S)  
R-990K(S)/(W)

## OPERATION MANUAL

### CONTENTS Page

Warranty	1
Introduction	2
Warning	3
Special Notes and Warning	4
Installation Instructions	5
Oven Diagram	5
Operation of Touch Control Panel	6
Control Panel Display	6
Touch Control Panel Layout	6
Before Operating	7
Getting Started	7
Clock Setting	7
Stop/Clear	7
To Cancel Program	7
Microwave Cooking	8
Microwave Time Cooking	8
Sequence Cooking	9
Instant Cook	9
Heating without Food	10
Convection Cooking	10
To Cook by Convection	10
To Preheat and Cook by Convection	11
Mix Cooking	12
To Use Automatic Mix Settings	12
To Preheat and Cook with Automatic Mix Settings	13
Convection and Microwave Cooking	14
Grilling	15
Preheating	16
Automatic Operations	17
Notes for Automatic Operations	17
Sensor Instant Action	17
Reheat Sensor	18
Multi Cook	19
Easy Defrost	20
Other Convenient Features	21
Help Feature	21
Less/More Setting	24
Increasing/Decreasing Time	24
Memory	25
Alarm	25
Care and Cleaning	26
Service Call Check	26
Specifications	26
Cooking Guides	① - ⑬

# *Info Display*

# SHARP

## WARRANTY

### *Consumer Electronic Products*

#### **Congratulations on Your Purchase!**

This Sharp product is warranted against faults in material and manufacture for the period as stated in the table below.

If service is required during the warranty period, please contact your nearest Sharp Approved Service Centre. These repairs would be carried out at no charge to the owner, subject to the conditions specified herein.

This warranty does not extend to defects or injuries caused by or resulting from causes not attributable to faulty parts or the manufacture of the product, including but not limited to, defect or injury caused by or resulting from misuse, abuse, neglect, lack of maintenance, accidental damage, improper voltage, liquid spillage, vermin infestation, software, or any alterations made to the product which are not authorised by Sharp.

Please retain your sales documentation, as this should be produced to validate a warranty claim. This warranty is in addition to and in no way limits, varies or excludes any implied rights and remedies under any relevant legislation in the country of sale.

This warranty does not cover transportation to and from the Sharp Approved Service Centre. Goods presented for repair may be replaced by refurbished goods of the same type rather than being repaired. Refurbished parts may be used to repair the goods. The repair of your goods may result in the loss of user generated data, please ensure that you have saved this data elsewhere prior to repair.

Australian customers: Our goods come with guarantees that cannot be excluded under the Australian Consumer Law. You are entitled to a replacement or refund for a major failure and for compensation for any other reasonably foreseeable loss or damage. You are also entitled to have the goods repaired or replaced if the goods fail to be of acceptable quality and the failure does not amount to a major failure. The criteria of a major failure is defined in the Australian Consumer Law. Should you require any assistance with a major failure please contact Sharp Customer Care.

#### **WARRANTY PERIODS**

Home Theatre Projector	12 months	(excluding lamps and air filters)
Audio/Home Theatre	12 months	
Microwave / Steam Oven	12 months	
Slow Juicer	12 months	
Refrigerator	24 months	
DVD/Blu-ray	12 months	
Washing Machine	24 months	
Portable Air Conditioner	12 months	
LCD Television	12 months	
Air Purifier	12 months	
Vacuum Cleaner	24 months	

**SHARP**  
SHARP CORPORATION OF AUSTRALIA PTY. LIMITED  
A/BV 40 003 039 405  
1 Huntingwood Drive  
Huntingwood NSW 2148  
SHARP CORPORATION OF NEW ZEALAND LIMITED  
59 Hugo Johnston Drive  
Penrose, Auckland

SPform 040 (SEPT 2013)

**IMPORTANT NOTICE: This warranty applies only to products sold in Australia & New Zealand**

**SHARP®**

FOR LOCATION ENQUIRIES WITHIN

**AUSTRALIA**

REGARDING YOUR LOCAL

SHARP APPROVED SERVICE CENTRE

VISIT OUR WEBSITE AT

**[www.sharp.net.au](http://www.sharp.net.au)**

OR CALL SHARP CUSTOMER CARE

**1300 135 022**

(LOCAL CALL COSTS APPLY WITHIN AUSTRALIA)

SHARP CORPORATION OF AUSTRALIA PTY LTD

**SHARP®**

FOR LOCATION ENQUIRIES WITHIN

**NEW ZEALAND**

REGARDING YOUR LOCAL

SHARP APPROVED SERVICE CENTRE

VISIT OUR WEBSITE AT

**[www.sharp.net.nz](http://www.sharp.net.nz)**

CONTACT YOUR SELLING DEALER/RETAILER

OR CALL

**SHARP CUSTOMER SERVICES**

TELEPHONE: 09 573 0111

FACSIMILE: 09 573 0113

SHARP CORPORATION OF NEW ZEALAND LIMITED

# INTRODUCTION

# SHARP®

## INFO DISPLAY COOKING SYSTEM

Thank you for buying a Sharp Microwave Oven.

Your new oven has an "Information Display System" which offers you step-by-step instructions to easily guide you through each feature.

Your oven also has a HELP key for instructions on using Auto Start, Information Guide On / Off, Demonstration Mode, Child Lock, Info on pads and Help.

After gaining experience and confidence using your oven, the information display can be turned off.

We strongly recommend however that you read this operation manual thoroughly before operating your oven, paying particular attention to the safety warnings and special notes.

The manual is divided into two sections:

**1. OPERATION (P3~P26)**

This section describes your oven and teaches you how to use all the features.

**2. COOKING GUIDE**

This section is at the back of the manual, it contains the more commonly used information such as how to prepare food, which cooking utensil to use, standing time.

It also contains recipes for automatic cooking.

Please take some time to read your operation manual carefully, the automatic cooking menus programmed into your new oven have been carefully developed to give optimum results when the step-by-step instructions are followed.

When selecting another home appliance, please again consider our full range of Sharp products.

# WARNING

IMPORTANT SAFETY INSTRUCTIONS : READ CAREFULLY AND KEEP FOR FUTURE REFERENCE.

Do not put things on top of the oven or cover the outer cabinet.

To reduce the risk of fire in the oven cavity:

- a. Do not overcook food.
- b. Remove wire twist-ties from paper or plastic bags before placing bag in the oven.
- c. Do not heat oil or fat for deep frying. The temperature of the oil cannot be controlled.
- d. Look at the oven from time to time when food is heated in disposable containers made of plastic, paper or other combustible materials for signs of smoke or burning.
- e. If materials inside the oven should ignite, or smoke is observed, keep oven door closed, turn oven off, and disconnect the power plug, or shut off power at the fuse or circuit breaker panel.

To reduce the risk of an explosion or delayed eruptive boiling when handling the container.

Your microwave oven is capable of heating food and beverages very quickly therefore, it is very important that you select the appropriate cooking time and power level for the type and quantity of food to be heated. If you are unsure of the cooking time and power level required, begin with low cooking times and power levels until the food is sufficiently heated evenly throughout.

Additionally:

- a. Do not place sealed containers in the oven. Babies bottles fitted with a screw cap or teat are considered to be sealed containers.
- b. Do not use excessive amount of time.
- c. When boiling liquids in the oven, use a wide-mouthed container.
- d. Stand at least for 20 seconds at the end of cooking to avoid delayed eruptive boiling of liquids.
- e. Stir the liquid before and during cooking. Use extreme care when handling the container or inserting a spoon or other utensil into the container.

This oven is for home food preparation only and should only be used for heating, cooking and defrosting food and beverage.

It is not suitable for commercial, laboratory use, or heating therapeutic devices eg. Wheat bags.

Never operate the oven whilst any object is caught or jammed between the door and the oven.

Do not try to adjust or repair the oven yourself.

It is hazardous for anyone other than a qualified service technician trained by SHARP to carry out any service or repair operation. Especially those which involve the removal of a cover which gives protection against exposure to microwave energy are very hazardous.

Do not operate the oven if it is not working correctly or damaged until it has been repaired by a qualified service technician trained by SHARP. It is particularly important that the oven door closes properly and that there is no damage to:

(1) Door (warped), (2) Hinges and Latches (broken or loosened), (3) Door Seals, Sealing Surfaces and oven cavity (bucked or deformed), (4) Burn marks on the door seal faces.

Do not bump, or catch utensils, loose clothes and your accessories on the door safety latches when removing food from the oven.

Never poke an object, particularly a metal object, through a grille or between the door and the oven while the oven is operating.

Never tamper with or deactivate the door safety latches.

Always use oven gloves to prevent burns when handling utensils that are in contact with hot food. Enough heat from the food can transfer through utensils to cause skin burns.

Should the power supply cord become damaged, it must be replaced with a special cord supplied by a SERVICE CENTRE APPROVED BY SHARP. And it must be replaced by a qualified service technician trained by SHARP in order to avoid a hazard.

If the oven lamp fails please consult your dealer or a qualified service technician trained by SHARP.

Avoid steam burns by directing steam away from the face and hands.

Slowly lift the furthest edge of a dish's cover including microwave plastic wrap etc., and carefully open popcorn and oven cooking bags away from the face.

Make sure that the power supply cord is undamaged, and that it does not run under the oven or over any hot surfaces or sharp edges.

Do not store food or any other items inside the oven.

Make sure the utensil does not touch the interior walls during cooking.

Accessible parts (e.g. oven door, oven cavity, dishes and accessories) may become hot during use. To avoid burns young children should be kept away. Always use thick oven gloves to prevent yourself from getting burnt.

Only allow children to use the oven without supervision when adequate instructions have been given so that the child is able to use the oven in a safe way and understands the hazards of improper use.

This appliance is not intended for use by young children or infirm persons without supervision.

Young children should be supervised to ensure that they do not play with the appliance.

When the appliance is operated in the combination mode (Mix Cooking), Convection Cooking, Grilling or Automatic Operations, children should only use the oven under adult supervision due to the temperature generated.

# SPECIAL NOTES AND WARNING

	DO	DON'T
Eggs, fruits, nuts, seeds, vegetables, sausages and oysters	<ul style="list-style-type: none"> <li>* Puncture egg yolks and whites and oysters before cooking to prevent "explosion".</li> <li>* Pierce skins of potatoes, apples, squash, hot dogs, sausages and oysters so that steam escapes.</li> </ul>	<ul style="list-style-type: none"> <li>* Cook eggs in shells. This prevents "explosion", which may damage the oven or injure yourself.</li> <li>* Cook hard/soft boiled eggs.</li> <li>* Overcook oysters.</li> <li>* Dry nuts or seeds in shells.</li> </ul>
Popcorn	<ul style="list-style-type: none"> <li>* Use specially bagged popcorn for the microwave oven.</li> <li>* Listen while popping corn for the popping to slow to 1-2 seconds.</li> </ul>	<ul style="list-style-type: none"> <li>* Pop popcorn in regular brown bags or glass bowls.</li> <li>* Exceed maximum time on popcorn package.</li> </ul>
Baby food	<ul style="list-style-type: none"> <li>* Transfer baby food to small dish and heat carefully, stirring often. Check for suitable temperature to prevent burns.</li> <li>* Remove the screw cap and teat before warming baby bottles. After warming shake thoroughly. Check for suitable temperature.</li> </ul>	<ul style="list-style-type: none"> <li>* Heat disposable bottles.</li> <li>* Overheat baby bottles. Only heat until warm.</li> <li>* Heat bottles with nipples on.</li> <li>* Heat baby food in original jars.</li> </ul>
General	<ul style="list-style-type: none"> <li>* Food with filling should be cut after heating, to release steam and avoid burns.</li> <li>* Use a deep bowl when cooking liquids or cereals to prevent boiling over.</li> </ul>	<ul style="list-style-type: none"> <li>* Heat or cook in closed glass jars or air tight containers.</li> <li>* Deep fat fry.</li> <li>* Heat or dry wood, herbs, wet papers, clothes or flowers.</li> <li>* Operate the oven without a load (i.e. an absorbing material such as food or water) in the oven cavity except when conditioning or cleaning the heater elements as described in the operation manual.</li> </ul>
Liquids (Beverages)	<ul style="list-style-type: none"> <li>* For boiling or cooking liquids see WARNING on page 2 to prevent explosion and delayed eruptive boiling.</li> </ul>	<ul style="list-style-type: none"> <li>* Heat for longer than recommended time. See REHEATING-FOOD CHART in the attached cookbook.</li> </ul>
Canned foods	<ul style="list-style-type: none"> <li>* Remove food from can.</li> </ul>	<ul style="list-style-type: none"> <li>* Heat or cook food while in cans.</li> </ul>
Sausage rolls, Pies, Christmas pudding	<ul style="list-style-type: none"> <li>* Cook for the recommended time. (These foods have high sugar and / or fat contents.)</li> </ul>	<ul style="list-style-type: none"> <li>* Overcook as they may catch fire.</li> </ul>
Meats	<ul style="list-style-type: none"> <li>* Use a microwave proof roasting rack to collect drained juices.</li> </ul>	<ul style="list-style-type: none"> <li>* Place meat directly on the turntable for cooking.</li> </ul>
Utensils	<ul style="list-style-type: none"> <li>* Check the utensils are suitable for MICROWAVE cooking before you use them.</li> </ul>	<ul style="list-style-type: none"> <li>* Use metal utensils for MICROWAVE cooking. Metal reflects microwave energy and may cause an electrical discharge known as arcing.</li> </ul>
Aluminium foil	<ul style="list-style-type: none"> <li>* Use to shield food to prevent over cooking.</li> <li>* Watch for sparking. Reduce foil or keep clear of cavity walls.</li> </ul>	<ul style="list-style-type: none"> <li>* Use too much.</li> <li>* Shield food close to cavity walls. Sparking can damage the cavity.</li> </ul>
Browning dish	<ul style="list-style-type: none"> <li>* Place a suitable insulator such as a microwave and heat proof dinner plate between the turntable and the browning dish.</li> </ul>	<ul style="list-style-type: none"> <li>* Exceed the preheating time recommended by the manufacturer. Excessive preheating can cause the glass turntable to shatter and/or damage internal parts of the oven.</li> </ul>

# INSTALLATION INSTRUCTIONS

- Remove all packing materials from the oven cavity, (**do not remove the waveguide cover**), and the feature sticker from the outside of the door, if there is one. Check the unit for any damage, such as a misaligned door, damaged door seals around the door or dents inside the oven cavity or on the door. If there is any damage, please do not operate the oven until it has been checked by a SERVICE CENTRE APPROVED BY SHARP and repaired, if necessary.
- Accessories provided
  - Turntable tray
  - Roller stay
  - Low rack
  - High rack
  - Cook book
  - Operation manual
- Since the door may become hot during cooking, you should place or mount the oven so that the bottom of the oven is 80 cm or more above floor. You should also keep children away from the door to prevent them burning themselves.
- Locate the roller stay in the centre of the oven, then fit the turntable on the roller stay. Make sure the turntable and roller stay are centrally located and locked together. **NEVER** operate the oven without the roller stay and turntable.
- The oven should not be installed in any area where heat and steam are generated, for example, next to a conventional oven unit. The oven should be installed so as not to block ventilation openings. When the oven is mounted on a kitchen benchtop, allow space of at least 40 cm on the top, 5 cm on both sides and at the rear of the oven for adequate air circulation.  
**WARNING:** The electrical outlet must be readily accessible so that the unit can be unplugged easily in an emergency.
- Neither the manufacturer nor the distributors can accept any liability for damage to the machine or personal injury for failure to observe the correct electrical connecting procedure.  
 The A.C. voltage must be single phase • 230V-240V, 50Hz
- This appliance must be earthed.
- Operate the oven from a general purpose domestic outlet.  
 If a generator is used, do not operate the oven with non-sinusoidal outputs.
- To build the oven into a wall or kitchen cabinet, use an appropriate built-in kit. Sharp built-in kit model number RK-J90W for R-980J/R-990K(W) and RK-J90S for R-990J(S)/R-990K(S) are available which enable the microwave oven to be integrated within a kitchen, the kit is available from your retailer. This built-in kit has been tested according to Australian Standards. Sharp does not recommend the use of any other built-in kit. If the oven is to be positioned near a conventional oven, ensure that adequate space is allowed, and a suitable heat shield is incorporated between the two to prevent damage to the oven and the built-in kit caused by heat.
- Before using CONVECTION HEATER ELEMENTS for the first time, operate the oven without food for 20 minutes at 250°C. This will allow the oil that is used for rust protection to be burned off.

## OVEN DIAGRAM

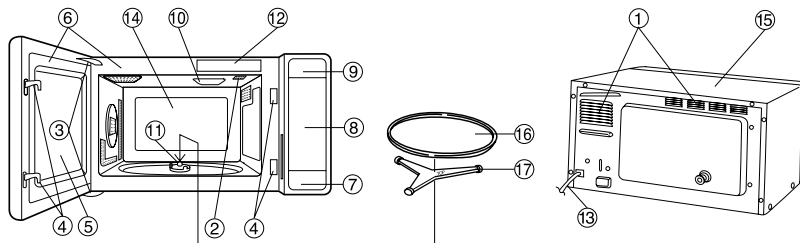

- |                                    |                                     |                       |
|------------------------------------|-------------------------------------|-----------------------|
| 1. Ventilation openings            | 7. Door open button                 | 13. Power supply cord |
| 2. Oven lamp                       | 8. Touch control panel              | 14. Oven cavity       |
| 3. Door hinges                     | 9. Digital readout                  | 15. Outer cabinet     |
| 4. Door safety latches             | 10. Waveguide cover (Do not remove) | 16. Turntable         |
| 5. See through door                | 11. Coupling                        | 17. Roller stay       |
| 6. Door seals and sealing surfaces | 12. Menu label                      |                       |

### NOTE:

The front-side design is slightly different due to the model you purchased.

### Metal racks—High and low

The racks are for Convection, Mix and Grilling. When cooking on Convection or Mix, do not substitute similar types of racks for these specially designed ones.

#### High Rack

-This rack is used for two level cooking in Convection, such as layer cakes, muffins, biscuits, etc., or for Grill cooking.

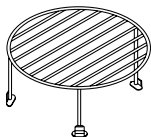

#### Low Rack

-This rack is recommended for roasting and baking in Convection or Mix mode and can be used for reheating and cooking foods by microwave.

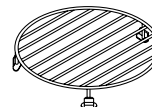

### WARNING:

The accessories will become very hot when in use. Use thick oven gloves when inserting/removing the food or turntable from the oven to PREVENT BURNS.

# OPERATION OF TOUCH CONTROL PANEL

The operation of the oven is controlled by pressing the appropriate pads arranged on the surface of the control panel.

An entry signal tone should be heard each time you press the control panel to make a correct entry.

In addition an audible signal will sound for approximately 2 seconds at the end of the cooking cycle, or 4 times when cooking procedure is required.

## Control Panel Display



## Touch Control Panel Layout

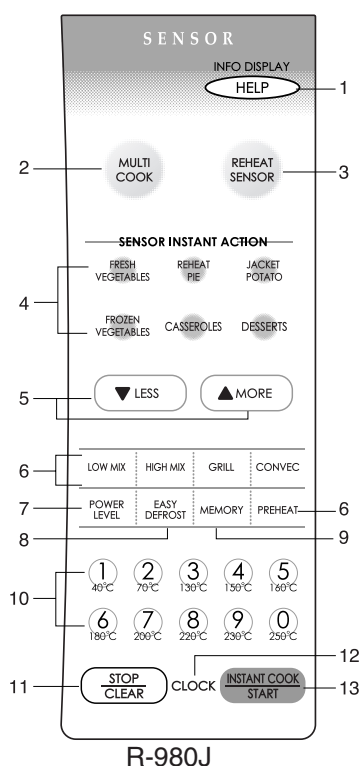

R-980J

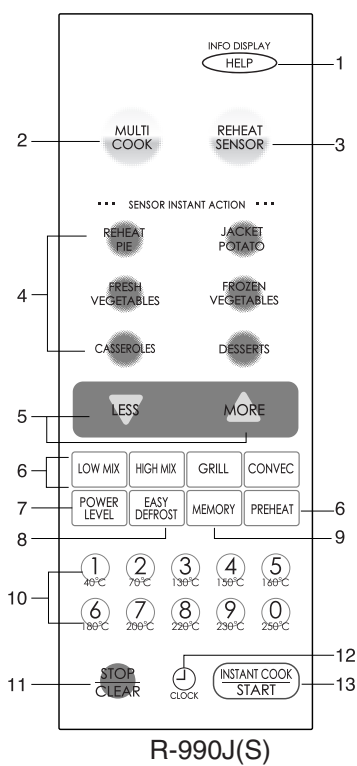

R-990J(S)

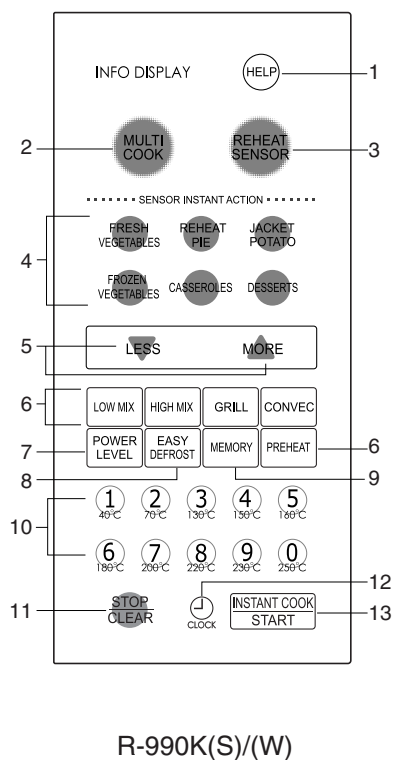

R-990K(S)/(W)



1. **HELP PAD**  
Press to select auto start, information guide on/off, child lock, demonstration modes or info on pads. Press to obtain cooking information.
2. **MULTI COOK PAD**  
Press to select Multi Cook mode.
3. **REHEAT SENSOR PAD**  
Press to select 3 popular Reheat menus.
4. **SENSOR INSTANT ACTION PADS**  
Press once to cook or reheat 6 popular menus.
5. **MORE(▲), LESS(▼) PADS**  
Press to increase/decrease the time in one minute increments during cooking or to alter the cooking result for the Sensor Instant Action, Reheat Sensor, Multi Cook or Easy Defrost modes.
6. **CONVECTION COOKING FUNCTION PADS**  
Press to cook with either function.
7. **POWER LEVEL PAD**  
Press to select microwave power setting. If not pressed, HIGH is automatically selected.
8. **EASY DEFROST PAD**  
Press to defrost meat by entering weight.
9. **MEMORY PAD**  
Press to enter the frequently used cooking programme. Press to recall the memorised programme.
10. **NUMBER AND TEMPERATURE PADS**  
Press to enter cooking times, clock time, convection temperature or to select the Multi Cook menus.
11. **STOP/CLEAR PAD**  
Press to clear during programming. Press once to stop operation of oven during cooking; press twice to cancel cooking programme.
12. **CLOCK PAD**  
Press to set clock time.
13. **INSTANT COOK/START PAD**  
Press once to cook for 1 minute on HIGH or increase by 1 minute multiples each time this pad is pressed during Microwave, Convection, Grill or Mix cooking. Press to start oven after setting programmes.



# BEFORE OPERATING

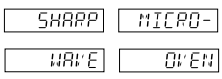

- \* This oven is preset with the INFORMATION GUIDE ON.  
To assist you in programming your oven, the information guide will appear in the display. In this manual, the display of information guide is abbreviated.
- \* When you become familiar with your oven, the information guide can be turned off. Check page 22.

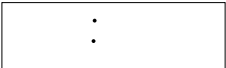
## Getting Started

Step	Procedure	Pad Order	Display
1	Plug the oven into a power point and switch on the power. Ensure the oven door is closed.		
2	Press the STOP/CLEAR pad so that the oven beeps.		 <p>Only the dots will remain.</p>

## Clock Setting

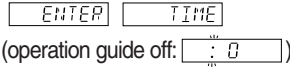
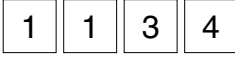
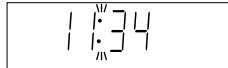
\* To enter the present time of day 11:34 (AM or PM).

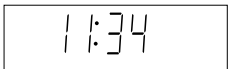
Step	Procedure	Pad Order	Display
1	Press the CLOCK pad.		
2	Enter the correct time of day by pressing the numbers in sequence.		 <p>The dots (:) will flash on and off.</p>
3	Press the CLOCK pad again.		

This is a 12 hour clock. If you attempt to enter an incorrect clock time (eg. 13:45) ERROR will appear in the display. Press the STOP/CLEAR pad and re-enter the time of day (eg. 1:45).  
If you wish to know the time of day during the cooking, auto start or timer mode, press the CLOCK pad. As long as your finger is pressing the CLOCK pad, the time of day will be displayed.

## Stop/Clear

Use the STOP/CLEAR pad to:

1. Stop the oven temporarily during cooking.
2. Clear if you make a mistake during programming.

## To Cancel a Programme During Cooking

Press the STOP/CLEAR pad twice.

# MICROWAVE COOKING

## Microwave Time Cooking

This is a manual cooking feature. First enter the cooking time then the power level. You can programme up to 99 minutes, 99 seconds. There are five different power levels.

Power level	<table border="1" style="width: 100%; text-align: center;"> <tr> <td>LOW</td> <td>M•LOW</td> <td>MEDIUM</td> <td>M•HIGH</td> <td>HIGH</td> </tr> </table>					LOW	M•LOW	MEDIUM	M•HIGH	HIGH
LOW	M•LOW	MEDIUM	M•HIGH	HIGH						
Approximate percentage of microwave power	<table border="1" style="width: 100%; text-align: center;"> <tr> <td>10%</td> <td>30%</td> <td>50%</td> <td>70%</td> <td>100%</td> </tr> </table>					10%	30%	50%	70%	100%
10%	30%	50%	70%	100%						
Examples of foods typically cooked on microwave oven power level	Keeping food warm	Defrost Softening butter	Casseroles Seafood	Cakes Muffins Slices	Fruit Vegetables Rice/Pasta					

This variable cooking control allows you to select the rate of microwave cooking.

If a power level is not selected, then HIGH power is automatically used.

\* Suppose you want to time cook for 10 minutes on HIGH power.

Step	Procedure	Pad Order	Display
1	Enter desired cooking time.	1 0 0 0	10.00
2	Press the INSTANT COOK/START pad.	INSTANT COOK START	10.00 COOK  The timer begins to count down.

To lower the power press the POWER LEVEL pad once. Note the display will indicate "HIGH". To lower to "M•HIGH" press the POWER LEVEL pad again. Repeat as necessary to select "MEDIUM", "M•LOW" or "LOW" power levels.

\* Suppose you want to cook Fish Fillets for 10 minutes on MEDIUM power.

Step	Procedure	Pad Order	Display
1	Enter desired cooking time.	1 0 0 0	10.00
2	Select microwave cooking and power level by pressing the POWER LEVEL pad as required (for MEDIUM press three times).	POWER LEVEL x 3	MEDIUM
3	Press the INSTANT COOK/START pad.	INSTANT COOK START	10.00 COOK  The timer begins to count down.

If the door is opened during cooking process, the cooking time in the display automatically stops. The cooking time starts to count down again when the door is closed and the INSTANT COOK/START pad is pressed.

If you want to check the power level during the cooking, press the POWER LEVEL pad.







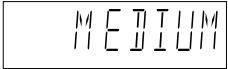
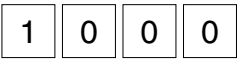
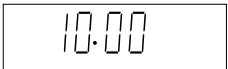

As long as your finger is pressing the POWER LEVEL pad, the power level will be displayed.

## Sequence Cooking

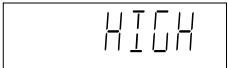
Your oven can be programmed with up to 4 automatic cooking sequences, automatically switching from one variable power setting to the next.

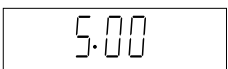

Note that POWER LEVEL must be entered first when programming sequence cooking.

\* Suppose you want to cook for 10 minutes on MEDIUM followed by 5 minutes on HIGH.

Step	Procedure	Pad Order	Display
1	Select microwave cooking and desired power level by pressing the POWER LEVEL pad (for MEDIUM press three times).	 x 3	
2	Enter desired cooking time.		
3	For second sequence, select microwave cooking and power level (for HIGH press the POWER LEVEL pad once)		
4	Enter desired cooking time for the second sequence.		
5	Press the INSTANT COOK/START pad.		 The timer begins to count down to zero. When it reaches zero,  the second sequence will appear and the timer will begin counting down to zero again.

## Instant Cook™







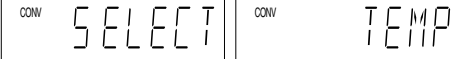

For your convenience Sharp's Instant Cook allows you to easily cook for one minute on HIGH power.

Step	Procedure	Pad Order	Display
1	Press the INSTANT COOK/START pad.  Within one minute of closing the door.		 The timer begins to count down.

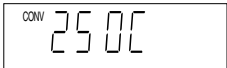
Press the INSTANT COOK/ START pad until desired time is displayed. Each time the pad is pressed, the cooking time is increased by 1 minute.

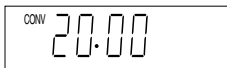
# HEATING WITHOUT FOOD

Before the first use and after cleaning the convection heater must be conditioned. The procedure involves heating for a period of 20 minutes. You may notice some smoke and odour during this process, the oven is not out of order. Follow the procedure below.

Step	Procedure	Pad Order	Display
1	Ensure that no food is in the oven. Press the CONVEC pad.		 (Operation guide off :  )
2	Enter the temperature (250°C).		
3	Enter the heating time (20 min.).		
4	Press the INSTANT COOK/START pad. <b>IMPORTANT:</b> During this operation, some smoke and odour will occur. Therefore open the windows or run the ventilation fan in the room		 The timer begins to count down to zero. When timer reaches zero, all indicators will go out and the oven will "beep".  will appear on the display.
5	Open the door to cool the oven cavity. The cooling fan will remain on until the oven cavity has cooled.		

## WARNING:

Accessible parts (e.g. oven door, oven cavity, dishes and accessories) will become hot when in use. To prevent burns, always use thick oven gloves.









# CONVECTION COOKING

Please consult your Convection Microwave Cookbook for more specific cooking instructions and procedures.

## To Cook by Convection

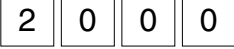
Your Convection Microwave Oven can be programmed for ten different convection cooking temperatures up to 99 minutes, 99 seconds.

\* Suppose you want to cook for 20 minutes at 180°C.

Step	Procedure	Pad Order	Display
1	Place turntable in the oven. Press the CONVEC pad.		 (Operation guide off :  )
2	Enter desired temperature.		
3	Enter desired cooking time.		
4	Press the INSTANT COOK/START pad.		 The timer begins to count down to zero. When timer reaches zero, all indicators will go out and the oven will "beep".  will appear on the display. The cooling fan will remain on until the oven cavity has cooled.

## HELPFUL HINT:

If you are cooking and wish to check the temperature you have programmed, simply press the CONVEC pad. The programmed temperature will be displayed as long as CONVEC pad is pressed.

## WARNING:

Accessible parts (e.g. oven door, oven cavity, dishes and accessories) will become hot when in use. To prevent burns, always use thick oven gloves.

## To Preheat and Cook by Convection

\* Suppose you want to preheat the oven to 200°C then cook for 20 minutes at 200°C.

Step	Procedure	Pad Order	Display
1	Press the PREHEAT pad.	PREHEAT	CONV SELECT
			CONV PREHEAT
2	Press desired preheat temperature pad.	7 200°C	CONV 200C
			(Operation guide off : <input type="checkbox"/> E <input type="checkbox"/> )
3	Press the CONVEC pad.	CONVEC	CONV SELECT
			CONV TEMP
4	Press desired cooking temperature pad.	7 200°C	CONV 200C
			(Operation guide off : <input type="checkbox"/> E <input type="checkbox"/> )
5	Enter desired cooking time.	2 0 0 0	CONV 20.00
6	Press the INSTANT COOK/START pad.  When "ADD FOOD" is displayed, the oven is preheated. If the oven door is not opened, the oven will automatically hold at the preheat temperature for 30 minutes.	INSTANT COOK START	CONV PREHEAT COOK
			will be displayed repeatedly. When preheat is over, the oven will "beep" 4 times and <input type="checkbox"/> ADD <input type="checkbox"/> <input type="checkbox"/> FOOD <input type="checkbox"/> will be displayed.
7	Open the door. Place food in oven. Close the door.		<input type="checkbox"/> PRESS <input type="checkbox"/> START will be displayed.
8	Press the INSTANT COOK/START pad.	INSTANT COOK START	CONV 20.00 COOK  The timer begins to count down to zero.

### HELPFUL HINT:

If you are cooking and wish to check the temperature you have programmed, simply press the CONVEC pad. The programmed temperature will be displayed as long as CONVEC pad is pressed.

### WARNING:

Accessible parts (e.g. oven door, oven cavity, dishes and accessories) will become hot when in use. To prevent burns, always use thick oven gloves.









# MIX COOKING

Your Convection Microwave Oven has two preprogrammed settings that make it easy to cook with both convection heat and microwaves automatically.

The LOW MIX pad is preprogrammed for 180°C with 10% microwave power, while the HIGH MIX pad is preprogrammed for 200°C with 30% microwave power.

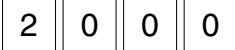
## To Use Automatic Mix Settings

\* Suppose you want to bake a cake for 20 minutes on LOW MIX.

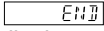
Step	Procedure	Pad Order	Display
1	Press the LOW MIX pad.		  
2	Enter desired cooking time.		
3	Press the INSTANT COOK/START pad.		 <p>The timer begins to count down to zero.            When timer reaches zero, all indicators will go out and the oven will "beep".   will appear on the display.            The cooling fan will remain on until the oven cavity has cooled.</p>

### NOTE

- To cook on HIGH MIX setting, use the above procedure, pressing the HIGH MIX pad in Step 1.
- If you want to change convection temperature of Automatic Mix Settings, using the above procedure, press the desired Mix setting pad again after step 1 and then press the desired temperature pad. And continue Step 2.

### HELPFUL HINT:

If you are cooking and wish to check the temperature you have programmed, simply press the CONVEC pad. The programmed temperature will be displayed as long as CONVEC pad is pressed.

### WARNING:

Accessible parts (e.g. oven door, oven cavity, dishes and accessories) will become hot when in use. To prevent burns, always use thick oven gloves.

# To Preheat and Cook with Automatic Mix Settings

\* Suppose you want to preheat the oven to 200°C and roast a chicken for 20 minutes on HIGH MIX.

Step	Procedure	Pad Order	Display
1	Press the PREHEAT pad.	<div style="border: 1px solid black; padding: 5px; display: inline-block;">PREHEAT</div>	<div style="border: 1px solid black; padding: 2px; display: inline-block;">CONV SELECT</div>
			<div style="border: 1px solid black; padding: 2px; display: inline-block;">CONV PREHEAT</div>
2	Press desired preheat temperature pad.	<div style="border: 1px solid black; padding: 2px; display: inline-block;">7 200°C</div>	<div style="border: 1px solid black; padding: 2px; display: inline-block;">CONV 200C</div>
			<div style="border: 1px solid black; padding: 2px; display: inline-block;">CONV TEMP</div>
(Operation guide off : <span style="border: 1px solid black; padding: 0 5px;">E</span> )			
3	Press the HIGH MIX pad.	<div style="border: 1px solid black; padding: 5px; display: inline-block;">HIGH MIX</div>	<div style="border: 1px solid black; padding: 2px; display: inline-block;">MIX HIGH</div>
			<div style="border: 1px solid black; padding: 2px; display: inline-block;">MIX MIX</div>
			<div style="border: 1px solid black; padding: 2px; display: inline-block;">MIX 200C</div>
4	Enter desired cooking time.	<div style="display: inline-block; border: 1px solid black; padding: 2px;">2</div> <div style="display: inline-block; border: 1px solid black; padding: 2px;">0</div> <div style="display: inline-block; border: 1px solid black; padding: 2px;">0</div> <div style="display: inline-block; border: 1px solid black; padding: 2px;">0</div>	<div style="border: 1px solid black; padding: 2px; display: inline-block;">MIX 20.00</div>
5	Press the INSTANT COOK/START pad.  When "ADD FOOD" is displayed, the oven is preheated. If the oven door is not opened, the oven will automatically hold at the preheat temperature for 30 minutes.	<div style="border: 1px solid black; padding: 5px; display: inline-block;">INSTANT COOK START</div>	<div style="border: 1px solid black; padding: 2px; display: inline-block;">CONV PREHEAT COOK</div>
			will be displayed repeatedly. When preheat is over, the oven will "beep" 4 times and <span style="border: 1px solid black; padding: 0 5px;">ADD</span> will be displayed. <span style="border: 1px solid black; padding: 0 5px;">FOOD</span> will be displayed.
6	Open the door. Place food in oven. Close the door.		<div style="border: 1px solid black; padding: 2px; display: inline-block;">PRESS</div> <div style="border: 1px solid black; padding: 2px; display: inline-block;">START</div> will be displayed.
7	Press the INSTANT COOK/START pad.	<div style="border: 1px solid black; padding: 5px; display: inline-block;">INSTANT COOK START</div>	<div style="border: 1px solid black; padding: 2px; display: inline-block;">MIX 20.00 COOK</div>
			The timer begins to count down to zero.

PREHEAT

COOKING

If you wish to change convection temperature of Automatic Mix settings, using the above procedure, press the desired Mix setting pad again after Step 3 and then press the desired temperature pad. And continue Step 4.







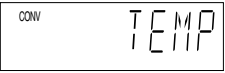

**WARNING:**

Accessible parts (e.g. oven door, oven cavity, dishes and accessories) will become hot when in use. To prevent burns, always use thick oven gloves.

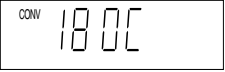
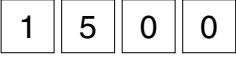
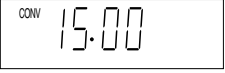
# Convection and Microwave Cooking

Your Convection Microwave Oven can be programmed to combine convection and microwave cooking operations.

\* Suppose you want to roast chicken pieces for 15 minutes at 180°C and then cook at 8 minutes on MEDIUM.

Step	Procedure	Pad Order	Display
1	Press the CONVEC pad.	<b>CONVEC</b>	  (Operation guide off:  )
2	Enter desired convection temperature.		
3	Enter desired convection cooking time.		
4	Select microwave cooking and power level by pressing the POWER LEVEL pad as required (for MEDIUM press three times.)	<b>POWER LEVEL</b> x 3	
5	Enter desired microwave cooking time.		
6	Press the INSTANT COOK/START pad.	<b>INSTANT COOK START</b>	 The timer begins to count down to zero. When it reaches zero,  The timer begins to count down to zero.

Do not use plastic (non-heat proof) cookware if combining Convection and Microwave mode.

**WARNING:**  
 Accessible parts (e.g. oven door, oven cavity, dishes and accessories) will become hot when in use. To prevent burns, always use thick oven gloves.













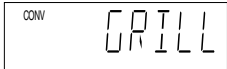
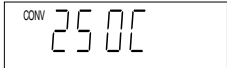



# GRILLING

The grill effect is achieved using fan forced heat at a temperature of 250°C.

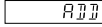
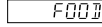
Preheating is automatic when the GRILL setting is used. Only actual cooking time is entered; the oven signals when it is preheated to 250°C. Use Grill setting for steaks, chops, chicken pieces and many other foods.

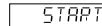
The turntable should remain in oven when preheating.

\* Suppose you want to grill a steak for 15 minutes.

Step	Procedure	Pad Order	Display
1	Place turntable in the oven. Press the GRILL pad.		 
2	Enter desired grilling time.	   	
3	Press the INSTANT COOK/START pad.		 will be displayed repeatedly. When preheat is over, the oven will "beep" 4 times and   will be displayed.
4	Open the door and place food in oven. Close the door.		  will be displayed.
5	Press the INSTANT COOK/START pad.		 The timer begins to count down to zero. When it reaches zero, all indicators will go off and the oven will "beep".  will appear on the display. The cooling fan will remain on until the oven cavity has cooled.

\* Oven will maintain 250°C for 30 minutes after preheat is completed. If the oven door is not opened (food placed in the oven) within 30 minutes, the oven will automatically turn off.

## HELPFUL HINT:

If you are cooking and wish to check the temperature you have programmed, simply press the CONVEC pad. The programmed temperature will be displayed as long as CONVEC pad is pressed.

## WARNING:

Accessible parts (e.g. oven door, oven cavity, dishes and accessories) will become hot when in use. To prevent burns, always use thick oven gloves.

# PREHEATING

For best results, preheat to the required temperature with the turntable in the oven. Add food after preheating.

\* To preheat the oven to 200°C

Step	Procedure	Pad Order	Display
1	Press the PREHEAT pad.	<b>PREHEAT</b>	<div style="display: flex; justify-content: space-between;"> <div style="border: 1px solid black; padding: 2px;">CONV SELECT</div> <div style="border: 1px solid black; padding: 2px;">CONV PREHEAT</div> </div> <div style="border: 1px solid black; padding: 2px; margin-top: 5px;">CONV TEMP</div> <p>(Operation guide off: <span style="border: 1px solid black; padding: 0 5px;">E</span>)</p>
2	Select preheating temperature.	<b>7</b> 200°C	<div style="border: 1px solid black; padding: 2px; text-align: center;">CONV 200C</div>
3	Press the INSTANT COOK/ START pad.	<b>INSTANT COOK START</b>	<div style="border: 1px solid black; padding: 2px; text-align: center;">CONV PREHEAT COOK</div>
4	Preheat is over. If the oven door is not opened, the oven will automatically hold at the preheat temperature for 30 minutes.		<div style="display: flex; justify-content: space-between;"> <div style="border: 1px solid black; padding: 2px;">CONV PREHEAT COOK</div> <div style="border: 1px solid black; padding: 2px;">CONV OVER COOK</div> </div>

After preheating, Suppose you want to cook profiteroles for 20 minutes on convection 200°C.

5	Open the door and place food. Close the door.		<span style="border: 1px solid black; padding: 2px;">PRESS</span> <span style="border: 1px solid black; padding: 2px;">CONVEC</span> <span style="border: 1px solid black; padding: 2px;">OR MIX</span>
6	Press the CONVEC pad.	<b>CONVEC</b>	<div style="display: flex; justify-content: space-between;"> <div style="border: 1px solid black; padding: 2px;">CONV SELECT</div> <div style="border: 1px solid black; padding: 2px;">CONV TEMP</div> </div> <p>(Operation guide off: <span style="border: 1px solid black; padding: 0 5px;">E</span>)</p>
7	Enter desired temperature.	<b>7</b> 200°C	<div style="border: 1px solid black; padding: 2px; text-align: center;">CONV 200C</div>
8	Enter desired cooking time.	<b>2 0 0 0</b>	<div style="border: 1px solid black; padding: 2px; text-align: center;">CONV 20.00</div>
9	Press the INSTANT COOK/ START pad.	<b>INSTANT COOK START</b>	<div style="border: 1px solid black; padding: 2px; text-align: center;">CONV 20.00 COOK</div> <p>The timer begins to count down.</p>

After preheating, suppose you want to cook with automatic Mix settings. Press the HIGH MIX or LOW MIX pad instead of the CONVEC pad in Step 6, then continue with Step 8.

If you are in the process of preheating and wish to check the actual oven temperature, simply press the CONVEC pad. The actual oven temperature will be displayed as long as the CONVEC pad is pressed. If the oven temperature is below 40°C at this time, LO E will be displayed.

## WARNING:

Accessible parts (e.g. oven door, oven cavity, dishes and accessories) will become hot when in use. To prevent burns, always use thick oven gloves.

# AUTOMATIC OPERATIONS

## Notes for Automatic Operations

- Wipe off any moisture from the outside of cooking containers and the interior of the oven with a dry cloth or paper towel prior to cooking on SENSOR INSTANT ACTION or REHEAT SENSOR.
- After oven is plugged in, wait 2 minutes before using SENSOR INSTANT ACTION or REHEAT SENSOR.
- ERROR** will be displayed if:
  - more or less than the quantity or weight of foods suggested in the MULTI COOK or EASY DEFROST MENU GUIDE are programmed when the START pad is pressed.  
To clear, press the STOP/CLEAR pad and reprogramme.
  - the door is opened or the STOP/CLEAR pad is pressed until the cooking time is displayed. To clear, press the STOP/CLEAR pad and cook manually. See cookbook.
- When using the automatic features (SENSOR INSTANT ACTION, REHEAT SENSOR, MULTI COOK, EASY DEFROST), carefully follow the details provided in each MENU GUIDE to achieve the best result.  
If the details are not followed carefully, the food may be overcooked or undercooked or **ERROR** may be displayed.
- When cooking small quantities of food on SENSOR INSTANT ACTION or REHEAT SENSOR, the food may be cooked without displaying any remaining cooking time.
- Food weighing more or less than the quantity or weight listed in each MENU GUIDE, cook manually. See cookbook.
- When entering the weight of the food, round off the weight to the nearest 0.1kg(100g). For example, 1.65kg would become 1.7kg.
- To change the final cooking or defrosting result from the standard setting, press the MORE(▲) or LESS(▼) pad prior to pressing the each automatic operation pad.

## Sensor Instant Action

- Fresh Vegetables
  - Reheat Pie
  - Jacket Potato
  - Frozen Vegetables
  - Casseroles
  - Desserts
- Press once to cook 6 popular menus. Follow the instructions provided in SENSOR INSTANT ACTION MENU GUIDE or SENSOR INSTANT ACTION RECIPES on pages ⑥ - ⑧ of the cooking guides.

\* Suppose you want to cook 1.0 kg Fresh Vegetables.

Step	Procedure	Pad Order	Display
<b>1</b>	<p>Press the SENSOR INSTANT ACTION pad for Fresh Vegetables (within 1 minute of closing the door).</p> <p>*When the sensor detects the vapour from the food, the remaining cooking time will appear. (eg. remaining cooking time is approximately. 10 sec.)</p>	<div style="border: 1px solid black; padding: 5px; width: fit-content; margin: 0 auto;"> <b>FRESH VEGETABLES</b> </div>	<div style="display: flex; flex-direction: column; align-items: center;"> <div style="display: flex; justify-content: space-around; width: 100%;"> <div style="border: 1px solid black; padding: 2px; text-align: center;"> <small>SENSOR</small>  <b>FRESH</b>  <small>COOK</small> </div> <div style="border: 1px solid black; padding: 2px; text-align: center;"> <small>SENSOR</small>  <b>VEGE-</b>  <small>COOK</small> </div> </div> <div style="display: flex; justify-content: space-around; width: 100%; margin-top: 5px;"> <div style="border: 1px solid black; padding: 2px; text-align: center;"> <small>SENSOR</small>  <b>TABLES</b>  <small>COOK</small> </div> <div style="border: 1px solid black; padding: 2px; text-align: center;"> <small>SENSOR</small>  <b>SENSOR</b>  <small>COOK</small> </div> </div> <div style="border: 1px solid black; padding: 2px; text-align: center; margin-top: 5px;"> <small>SENSOR</small>  <b>COOKING</b>  <small>COOK</small> </div> <div style="border: 1px solid black; padding: 2px; text-align: center; margin-top: 5px;"> <small>SENSOR</small>  <b>.10</b>  <small>COOK</small> </div> </div> <p>The timer begins to count down. When the cooking time reaches zero, <b>STAND</b></p> <div style="display: flex; justify-content: space-between; font-size: small; margin-top: 5px;"> <span><b>COVERED</b></span> <span><b>1-5 MIN</b></span> <span><b>STIP</b></span> <span><b>ENJOY</b></span> </div> <div style="display: flex; justify-content: space-between; font-size: small; margin-top: 5px;"> <span><b>POUP</b></span> <span><b>VEGE-</b></span> <span><b>TABLES</b></span> </div> <p>will be displayed.</p>

**NOTE:** You can get a cooking hint by pressing the HELP pad before pressing the desired SENSOR INSTANT ACTION pad. See page 23.

**WARNING:** Accessible parts (e.g. oven door, oven cavity, dishes and accessories) will become hot when in use. To prevent burns, always use thick oven gloves.

# Reheat Sensor

1. Dinner Plate
2. Soup
3. Casseroles/Canned Food

Press to select 3 popular reheat menus.  
 Follow the instructions provided in REHEAT SENSOR MENU GUIDE on page ⑨ of the cooking guides.

Step	Procedure	Pad Order	Display
<b>1</b>	To reheat a Dinner Plate, press the REHEAT SENSOR pad <u>once</u> .	<div style="border: 1px solid black; padding: 2px; display: inline-block;">REHEAT SENSOR</div> x 1	
	If you require a cooking hint, press the HELP pad. (See NOTE below)	<div style="border: 1px solid black; padding: 2px; display: inline-block;">HELP</div>	
	To reheat Soup, press the REHEAT SENSOR pad <u>twice</u> within 3 seconds.	<div style="border: 1px solid black; padding: 2px; display: inline-block;">REHEAT SENSOR</div> x 2	
	To reheat Casseroles/Canned Food, press the REHEAT SENSOR pad <u>3 times</u> within 3 seconds.	<div style="border: 1px solid black; padding: 2px; display: inline-block;">REHEAT SENSOR</div> x 3	
<b>2</b>	Suppose you want to reheat a dinner plate. Press the INSTANT COOK/START pad.  * When the sensor detects the vapour from the food, the remaining cooking time will appear. (eg. remaining cooking time is approximately. 20 sec.)	<div style="border: 1px solid black; padding: 2px; display: inline-block;">INSTANT COOK START</div>	<p>The oven starts.</p> <p>The timer begins to count down.            When the cooking time reaches zero,             will be displayed .</p>

**NOTE:** You can get a cooking hint whenever HELP is lit in the display. See page 23.

# Multi Cook

- 1. Roast Beef
- 2. Roast Lamb
- 3. Roast Chicken
- 4. Roast Dinner
- 5. Grilled Steak/Chops
- 6. Biscuits

Press to select 6 popular convection and mix cooking menus. Follow the instructions provided in MULTI COOK MENU GUIDE or MULTI COOK RECIPES on pages 10 - 12 of the cooking guides.

\* Suppose you want to cook 1.0 kg Roast Beef (Medium).

Step	Procedure	Pad Order	Display
1	Press the MULTI COOK pad.	<b>MULTI COOK</b>	<b>SELECT</b> <b>FOOD</b> <b>NUMBER</b> (Operation guide off: <b>FOOD</b> )
2	Select food category for Multi Cook. Press 1 to cook Roast Beef.	<b>1</b>	MIX <b>ROAST</b> KG HELP MIX <b>BEEF</b> KG HELP KG will flash on and off.
3	Enter the weight.	<b>1</b> <b>0</b>	MIX <b>1.0</b> KG HELP KG stops flashing.
4	Press the INSTANT COOK/START pad.	<b>INSTANT COOK START</b>	MIX <b>31:10</b> COOK HELP The timer begins to count down. The oven will "beep" 4 times and will stop. <b>TURN</b> <b>BEEF</b> <b>OVER</b> will be displayed repeatedly.
5	Open the door. Turn over the meat. Close the door.		<b>PRESS</b> <b>START</b> will be displayed repeatedly.
6	Press the INSTANT COOK/START pad.	<b>INSTANT COOK START</b>	MIX <b>15:35</b> COOK HELP When the cooking time reaches zero, <b>STAND</b> <b>COVERED</b> <b>5-15MIN</b> <b>FOIL</b> <b>ENJOY</b> <b>YOUR</b> <b>BEEF</b> will be displayed repeatedly.

## NOTE:

- You can get a cooking hint whenever HELP is lit in the display. See page 23.
- For menus 3, 5 and 6: After Step 3, press the INSTANT COOK/START pad and preheat will start automatically. When the display shows **ADD** **CHICKEN**, **ADD** **TURN** **TABLE** **ADD** **STEAK** **CHOPS** or **ADD** **BISCUIT** open the door and enter the food. Then continue with Step 4.

## WARNING:





Accessible parts (e.g. oven door, oven cavity, dishes and accessories) will become hot when in use. To prevent burns, always use thick oven gloves.

# Easy Defrost

- Minced Meat
- Steak/Chops
- Chicken Pieces
- Poultry
- Roast Meat

The Easy Defrost feature allows you to defrost meats by entering weight. Follow the instructions provided in EASY DEFROST MENU GUIDE on page 13 of the cooking guides.

\* Suppose you want to defrost 1.0 kg of Chicken Pieces.

Step	Procedure	Pad Order	Display
1	Press the EASY DEFROST pad.	<b>EASY DEFROST</b>	  KG will flash on and off. (Operation guide off: <input type="text"/> )
2	Enter the weight.	1 0	 KG stops flashing.
3	Press the INSTANT COOK/START pad.	<b>INSTANT COOK START</b>	 The timer begins to count down. The oven will “beep” 4 times and will stop. REMOVE DEF- ROSEB PORTION TURN FOOD OVER SHIELD EDGES OR WARM PORTION will be displayed repeatedly.
4	Open the door. Turn over the chicken pieces. Close the door.		PRESS START will be displayed repeatedly.
5	Press the INSTANT COOK/START pad.	<b>INSTANT COOK START</b>	 The timer begins to count down, when it reaches zero, the oven will “beep”. STAND COVERED WITH FOIL will be displayed repeatedly.

**NOTE:** You can get a cooking hint whenever HELP is lit in the display. See page 23.

# OTHER CONVENIENT FEATURES











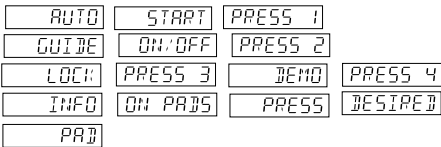

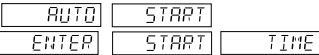



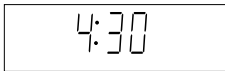

## Help Feature

The HELP feature has 6 different programmes.

### Auto Start

The Auto Start feature allows you to set your oven to start automatically.

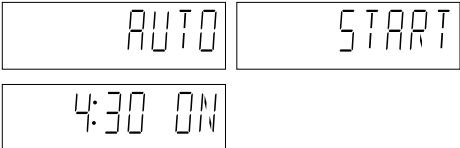
\* Suppose you want to start cooking a casserole for 20 minutes on MEDIUM at 4:30 in the afternoon.  
(Check that the correct time of day is displayed.)

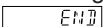
Step	Procedure	Pad Order	Display
1	Press the HELP pad.		
2	Press the number 1 pad.		
3	Enter the desired start time.	  	 The dots (:) will flash on and off.
4	Press the CLOCK pad.		
5	Set the desired cooking mode. (for microwave cooking on MEDIUM, press the POWER LEVEL pad 3 times)	 x 3	
6	Enter the desired cooking time.	   	
7	Press the INSTANT COOK/ START pad.		 The oven will start cooking at 4:30 P.M.  The timer begins to count down. When the timer reaches zero, all indicators will go off and the oven will "beep".  will appear in the display.

To check the current time, simply press the CLOCK pad, the time will be displayed.

If the door is opened after step 7, close the door and press the START pad to continue with Auto Start.  
Press the STOP/CLEAR pad to cancel Auto Start.



The correct time of day must be set before using Auto Start, see clock setting on page 7.

## Information Guide On/Off

This oven is preset with the Information Guide On.

As you get more familiar with your oven, the Information Guide can be turned off.

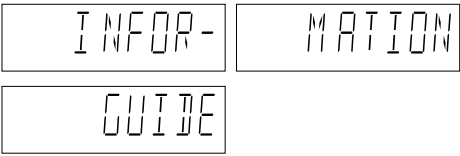
\* **To turn off the Information Guide.** After step 1 for Auto Start.

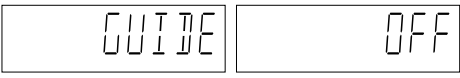
Step	Procedure	Pad Order	Display
2	Press the number 2 pad.		
3	Press the STOP/CLEAR pad.		 The time of day will appear in the display.

\* **To restore the Information Guide.** After step 2 above.

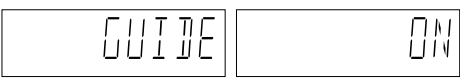

Step	Procedure	Pad Order	Display
3	Press the INSTANT COOK/START pad.		 The time of day will appear in the display.

## Child Lock

If the oven is accidentally started with no food or liquid in the cavity, the life of the oven may be reduced.

To prevent accidents like this, your oven has a "Child Lock" feature that you can set when the oven is not in use.

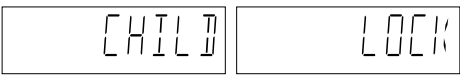
\* **To set the Child Lock.** After step 1 for Auto Start.

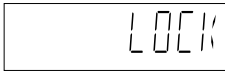
Step	Procedure	Pad Order	Display
2	Press the number 3 pad.		
3	Press the INSTANT COOK/START pad.		 The time of day will appear in the display.

The control panel is now locked, each time a pad is pressed, the display will show "LOCK".

\* **To unlock the control panel.** After step 2 above.

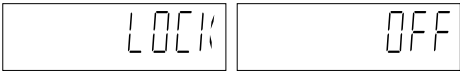
Step	Procedure	Pad Order	Display
3	Press the STOP/CLEAR pad.		 The time of day will appear in the display. The oven is ready to use.



## Demonstration Mode

This feature is mainly for use by retail outlets, and also allows you to practice key operations.

\* **To demonstrate.** After step 1 for Auto Start.

Step	Procedure	Pad Order	Display
2	Press the number 4 pad.	4	DEMO MODE
3	Press the INSTANT COOK/START pad.	INSTANT COOK START	DEMO Then SHARP MICPO- WAVE OPEN will appear repeatedly.

Cooking operations can now be demonstrated with no power in the oven.

\* **Suppose you demonstrate Instant Cook.**

Step	Procedure	Pad Order	Display
1	Press the INSTANT COOK/START pad. (Within one minute of closing the door.)	INSTANT COOK START	1:00 COOK The timer begins to count down to zero at ten times the speed. When the timer reaches zero, END will appear in the display.

\* **To cancel the Demonstration Mode.** After step 2 above.

Step	Procedure	Pad Order	Display
3	Press the STOP/CLEAR pad.	STOP CLEAR	DEMO OFF The time of day will appear in the display.

## Info on Pads

Each pad carries useful guide.

\* **To get the guide for MULTI COOK pad.** After step 1 for Auto Start.

Step	Procedure	Pad Order	Display
2	Press the MULTI COOK pad.	MULTI COOK	PRESS TO SELECT 1-6 PRESET MENUS

The guide message will be repeated twice, and then the display will show the time of day.

If you want to cancel the guide, press the STOP/CLEAR pad.

## Help

Each setting of Automatic Operations has a cooking hint.

If you wish to check, press the HELP pad whenever HELP is lit in the display.

**NOTE:** For SENSOR INSTANT ACTION, HELP is not lit in the display, so press the HELP pad before pressing the desired SENSOR INSTANT ACTION pad.

## Less/More Setting









The cooking times programmed into the automatic menus are tailored to the most popular tastes. To adjust the cooking time to your individual preference – use the “more” or “less” feature to either add (more) or reduce (less) cooking time.

The LESS/MORE pads can be used to adjust the cooking time of the following features

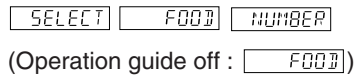
- SENSOR INSTANT ACTION
- MULTI COOK
- REHEAT SENSOR
- EASY DEFROST

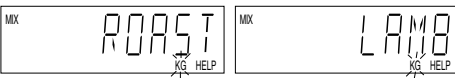
To adjust cooking time, press the LESS or MORE pad at the beginning of the procedure.

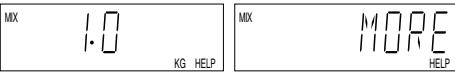







\* Suppose you want to cook 1.0 kg Roast Lamb (Well Done) with MULTI COOK.

Step	Procedure	Pad Order	Display
1	Press the MORE pad.		
2	Press the MULTI COOK pad.		
3	Select food category for Multi Cook. Press 2 to cook Roast Lamb.		
4	Enter the weight.	 	
5	Press the INSTANT/COOK START pad.		

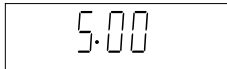
## Increasing or Decreasing Time During A Cooking Programme

Microwave, Convection, Mix or Grilling time can be added or decreased during a cooking programme using the “MORE” or “LESS” pads.

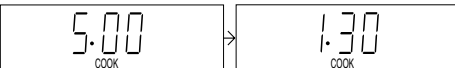
\* Suppose you want to increase cooking time by 2 minutes during 5 minutes on MEDIUM cooking.

Step	Procedure	Pad Order	Display
1	Enter desired cooking time.	  	
2	Select microwave cooking and power level by pressing the POWER LEVEL pad as required. (for MEDIUM press three times)	 x 3	
3	Press the INSTANT COOK/ START pad.		 The timer begins to count down.
4	Press the MORE pad twice to increase time by two minutes.	 x 2	









## Memory

Your oven has a memory to allow you to preset a frequently used cooking programme. The oven "memorises" the instruction and can recall this information when the time of day is displayed. This feature can be used for frequently prepared foods such as scrambled eggs, or special recipes you like to cook.

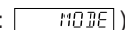
### MEMORY ENTRY/REPROGRAMME

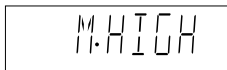
(Up to four stages can be memorised.)

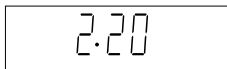

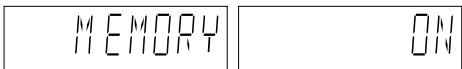

\*Suppose you want to enter 2 minutes 20 seconds on M•HIGH into the memory.

Step	Procedure	Pad Order	Display
1	Press the MEMORY pad twice.	 x 2	 (Operation guide off:  )
2	Select microwave cooking and power level by pressing the POWER LEVEL pad (for M•HIGH press twice).	 x 2	
3	Enter desired cooking time.		
4	Press the MEMORY pad.		

NOTE : If you wish to enter more than two stages cooking, repeat step 2 and 3 after step 3.

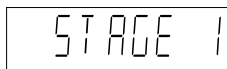
### COOKING BY MEMORY



\*Suppose you want to use the memorised cooking programme with memory.

Step	Procedure	Pad Order	Display
1	Press the MEMORY pad.		The memorised cooking programme will appear.  
2	Press the INSTANT COOK / START pad.		

### TO CHECK MEMORY

You may forget exactly what information is stored in the memory or simply want to check if the oven has been programmed correctly:

\*Suppose you want to check the cooking programme of memory.

Step	Procedure	Pad Order	Display
1	Press the MEMORY pad.		The memorized cooking programme will appear.
2	Press the STOP/CLEAR pad.		Time of day will appear.

## Alarm

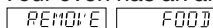
Your oven has an alarm function. If you leave food in the oven after cooking, the oven will "beep" 3 times and  will be appeared in the display after 2 minutes.

If you do not remove the food at that time, the oven will "beep" 3 times after 4 minutes and 6 minutes.

# CARE AND CLEANING

Disconnect the power supply cord before cleaning or leave the door open to inactivate the oven.  
Before cleaning ensure oven cavity is cool.

**CLEAN THE OVEN AT REGULAR INTERVALS** - Keep the oven clean and remove any food deposits, or it could lead to deterioration of the surface. This could adversely affect the life of the appliance and possibly result in a hazardous situation.

**Exterior:** The outside may be cleaned with mild soap and warm water, wipe clean with a damp cloth. Avoid the use of harsh abrasive cleaners. Keep the ventilation openings free of dust.

**Door:** Wipe the door and window on both sides, the door seals and adjacent parts frequently with a damp cloth to remove any spills or splatters. Do not use abrasive cleaner.

**Touch Control Panel:** Wipe the panel with a cloth dampened slightly with water only. Do not scrub or use any sort of chemical cleaners. Avoid the use of excess water.

**Interior walls:** Wipe splatters and spills with a little dish washing liquid on a soft damp cloth. For heavier stains inside the oven cavity only, use a mild stainless steel cleaner applied with a soft damp cloth. Do not apply to the inside of the door. Wipe clean ensuring all cleaner is removed.

After use wipe the waveguide cover in the oven with a soft damp cloth to remove any food splashes. Built-up splashes may overheat and begin to smoke or catch fire. Do not remove the waveguide cover.

**DO NOT USE CAUSTIC CLEANERS, ABRASIVE OR HARSH CLEANSERS OR SCOURING PADS ON YOUR OVEN. NEVER SPRAY OVEN CLEANERS DIRECTLY ONTO ANY PART OF YOUR OVEN.**

**DO NOT USE A STEAM CLEANER.** Avoid using excess water. After cleaning the oven, ensure any water is removed with a soft cloth.

**Note:** At regular intervals, heat the oven referring to "Heating without Food" on page 10. Because, the splashed dirt or food oil remained around oven walls may cause the smoke and odour.

**Turntable/Turntable Support/Racks:** Wash with mild soapy water and dry thoroughly.

**Note:** Keep the waveguide cover and accessories clean at all times. If you leave grease or fat in the cavity or accessories, it may overheat, cause arcing, smoke or even catch fire when next using the oven.

**SPECIAL NOTE for TURNTABLE SUPPORT:**

After cooking, always clean the turntable support, especially around the rollers. These must be free from food splashes and grease. Built-up splashes or grease may overheat and cause arcing, which may produce smoke or catch fire.



## SERVICE CALL CHECK

Please check the following before calling service:

1. Does the display light up? Yes \_\_\_\_\_ No \_\_\_\_\_
2. When the door is opened, does the oven lamp come on? Yes \_\_\_\_\_ No \_\_\_\_\_
3. Place one cup of water (approx. 250 ml) in a glass measuring cup in the oven and close the door securely. Oven lamp should go off if door is closed properly. Press the INSTANT COOK/START pad once.
  - A. Does the oven lamp come on? Yes \_\_\_\_\_ No \_\_\_\_\_
  - B. Does the cooling fan work? Yes \_\_\_\_\_ No \_\_\_\_\_  
(Put your hand over the rear ventilation openings.)
  - C. Does the turntable rotate? Yes \_\_\_\_\_ No \_\_\_\_\_  
(The turntable can rotate clockwise or counterclockwise. This is quite normal.)
  - D. Does the COOK indicator light up? Yes \_\_\_\_\_ No \_\_\_\_\_
  - E. After 1 minutes, is the water hot? Yes \_\_\_\_\_ No \_\_\_\_\_
4. Remove water from the oven and programme the oven for 5 minutes at convection 180°C.
  - A. Does the CONV and COOK indicators light up? Yes \_\_\_\_\_ No \_\_\_\_\_
  - B. After 5 minutes, is the inside of the oven hot? Yes \_\_\_\_\_ No \_\_\_\_\_

If "NO" is the answer to any of the above questions, please check your wall socket and the fuse in your meter box. If both the wall socket and the fuse are functioning properly, CONTACT YOUR NEAREST SERVICE CENTRE APPROVED BY SHARP.

NOTE:

1. If time in the display is counting down rapidly, check Demonstration Mode. (See P. 23 for detail.)
2. After manual or automatic cooking using the Grill, Mix or Convection modes, the cooling fan will switch on to cool the oven cavity. To clear it, press the STOP/CLEAR key and the display will return to the time of day, if set. During these modes, the cooling fan will carry on working after you have pressed the STOP/ CLEAR key. You may feel hot air blowing out of the ventilation openings.





## SPECIFICATIONS

Model Name	R-980J	R-990J(S)/R-990K(S)/R-990K(W)
AC Line Voltage	Single phase 230-240V, 50Hz	
AC Power Required	1.6 kW (Microwave) / 1.6 kW (Convection)	
Output Power		
Microwave	900 W* (IEC test procedure)	
Convection Heater	1500 W	
Microwave Frequency	2450 MHz**(Class B/Group 2)	
Outside Dimensions (WxHxD)	627mm x 378mm x 492mm	627mm x 378mm x 487mm
Depth with the door open	942mm	949mm
Turntable Diameter	390mm	
Cooking Uniformity	Turntable system	
Weight	Approx. 29 kg	

\* When tested in accordance with AS/NZS 2895.1.2004

\*\* This is the classification of ISM (Industrial, Scientific and Medical) equipment described in the International Standard CISPR11.

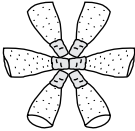
# EASY DEFROST MENU GUIDE

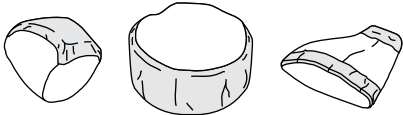
Menu		Quantity min-max (kg's)	Procedure	Standing Time (minutes)
<b>Minced Meat</b> Beef		0.1-3.0	<ul style="list-style-type: none"> <li>Place shielded frozen minced meat on a defrost rack.</li> <li>When the oven has stopped, remove defrosted portions of mince, turn over and shield edges with foil strips.</li> <li>After defrost time, stand covered with aluminium foil.</li> <li>See NOTE below.</li> </ul>	10-15
<b>Steak/Chops</b>		0.1-3.0	<ul style="list-style-type: none"> <li>Shield thin end of chops or steaks with foil.</li> <li>Position the food with thinner parts in the centre in a single layer on a defrost rack. If pieces are stuck together, try to separate as soon as possible.</li> <li>When the oven has stopped, remove defrosted pieces, turn over and shield the warm portions of remaining pieces.</li> <li>After defrost time, stand covered with aluminium foil.</li> <li>See NOTE below.</li> </ul>	10-15
<b>Chicken Pieces</b>		0.1-3.0	<ul style="list-style-type: none"> <li>Shield the exposed bone with foil.</li> <li>Place chicken pieces on a defrost rack.</li> <li>When the oven has stopped, remove any defrosted pieces, turn over and shield the warm portions of remaining pieces.</li> <li>After defrost time, stand covered with aluminium foil.</li> <li>See NOTE below.</li> </ul>	5-15
<b>Poultry</b>		1.0-4.0	<ul style="list-style-type: none"> <li>Remove from original wrapper. Shield wing and leg tips with foil.</li> <li>Place breast side down on a defrost rack.</li> <li>When the oven has stopped, turn over and shield the warm portions.</li> <li>After defrost time, stand covered with aluminium foil.</li> </ul> <p><b>N.B.</b> After standing run under cold water to remove giblets if necessary.</p>	15-50
<b>Roast Meat</b> Beef/Lamb Pork		0.5-3.0 0.5-4.0	<ul style="list-style-type: none"> <li>Shield the bone and the edge with foil strips about 2.5cm wide.</li> <li>Place joint with lean side face upwards (if possible) on a defrost rack.</li> <li>When the oven has stopped, turn over and shield the warm portions.</li> <li>After defrost time, stand covered with aluminium foil.</li> </ul>	15-50

Foods not listed in the Guide can be defrosted using M•LOW setting.

NOTE: When freezing minced meat, shape it into flat even sizes.

For chicken pieces, steaks and chops, freeze separately in single flat layers and if necessary interleave with freezer plastic to separate layers.

This will ensure even defrosting.

It is also a good idea to label the packs with the correct weights.

# Multi Cook Recipes

## GRILLED STEAK/CHOPS

### MARINADE FOR LAMB CHOPS/PORK CHOPS

#### *Spicy Plum Marinade*

(for 8 chops)

- 2 tablespoons tomato sauce
- 2 tablespoons honey
- 2 tablespoons soy sauce
- 2 tablespoons plum sauce
- 1 tablespoon mustard powder
- 2 tablespoons Worcestershire sauce

Mix all ingredients together.

Pour over meat and marinade 1 hour.

#### *Indian Marinade*

- 125 ml dry white wine
- 1 tablespoon lemon juice
- 3 tablespoons fruit chutney
- garlic to taste
- 2 tablespoons mixed herbs
- freshly ground black pepper

Mix all ingredients together.

Pour over meat and marinade 1 hour.

## BISCUITS

### *Chocolate Chip Cookies*

- |      |                                 |       |                                 |
|------|---------------------------------|-------|---------------------------------|
| 125g | butter                          | 1 3/4 | cups self-raising flour, sifted |
| 1/2  | cup caster sugar                | 1/2   | teaspoon salt                   |
| 1/2  | cup brown sugar, lightly packed | 125g  | choc bits                       |
| 1/2  | teaspoon vanilla                | 60g   | walnut pieces                   |
| 1    | egg                             |       |                                 |

1. Cream butter, sugar and vanilla until light and fluffy. Beat in egg.
2. Mix in flour, salt, choc bits and walnut pieces.
3. Shape tablespoonfuls of mixture into balls. Place on a lightly greased pizza tray; press down slightly, allowing room for spreading.
4. Cook on Multi Cook 6 (Biscuits).
5. After cooking, remove biscuits from the oven immediately and cool.

### *Anzac Biscuits*

- |      |                              |     |                 |
|------|------------------------------|-----|-----------------|
| 125g | butter                       | 1   | cup rolled oats |
| 2    | tablespoons golden syrup     | 1   | cup plain flour |
| 1/2  | teaspoon bicarbonate of soda | 1   | cup sugar       |
| 2    | tablespoons boiling water    | 3/4 | cup coconut     |



1. Combine butter and golden syrup in a small bowl. Cook for 2 minutes on HIGH.
2. Mix soda with boiling water; add to melted butter mixture.
3. Combine all dry ingredients; mix into butter.
4. Place teaspoonfuls of mixture on a lightly greased pizza tray.
5. Cook on Multi Cook 6 (Biscuits).
6. After cooking, remove biscuits from the oven immediately and cool.

### *Apricot Wheatgerm Crunchies*

- |      |                                 |       |                         |
|------|---------------------------------|-------|-------------------------|
| 125g | butter                          | 3/4   | cup wheatgerm           |
| 3/4  | cup brown sugar, lightly packed | 1/3   | cup coconut             |
| 1/2  | teaspoon vanilla essence        | 1/3   | cup rolled oats         |
| 1    | egg                             | 125g  | dried apricots, chopped |
| 1/2  | cup self-raising flour, sifted  | 1 1/2 | cups cornflakes         |

1. Cream butter and sugar together until light and fluffy. Add vanilla and egg. Beat well.
2. Mix in flour, wheatgerm, coconut, rolled oats, apricots and cornflakes.
3. Shape tablespoonfuls of mixture into balls.
4. Place on a greased pizza tray; flatten slightly with a fork.
5. Cook on Multi Cook 6 (Biscuits).
6. After cooking, remove biscuits from the oven immediately and cool.

# MULTI COOK MENU GUIDE

No.	Menu	 Weight Range	 Initial Temperature (approx.)	Cooking Method	Procedure	 Standing Time (minutes)														
5	<b>Grilled Steak/Chops</b> See recipes on page 12	0.1-1.5 kg	+3°C Refrigerated	Preheat CONV.	<ul style="list-style-type: none"> <li>Remove turntable before preheating.</li> <li>Preheat is automatic for this menu.</li> <li>ADD MEAT AFTER PREHEATING.</li> <li>Place on the high rack.</li> <li>Place 1/2 cup of cold water on the turntable to prevent excessive smoke when grilling (otherwise the dripping fat drops on the hot turntable causing the smoke).</li> <li>Place turntable with meat on the high rack in oven after preheating.</li> <li>After cooking, stand covered with aluminium foil.</li> </ul>	2-3														
	<table border="1"> <thead> <tr> <th>Type of Meat</th> <th>Approx. Weight</th> <th>Approx. thickness</th> </tr> </thead> <tbody> <tr> <td>T-bone steak</td> <td>240-380 g</td> <td>1.5 cm</td> </tr> <tr> <td>Rump steak</td> <td>250 g</td> <td>2-2.5 cm</td> </tr> <tr> <td>Pork chops (MORE setting only)</td> <td>245 g</td> <td>1.5 cm</td> </tr> <tr> <td>Lamb loin chops</td> <td>110-140 g</td> <td>1.5 cm</td> </tr> </tbody> </table>	Type of Meat	Approx. Weight	Approx. thickness	T-bone steak	240-380 g	1.5 cm	Rump steak	250 g	2-2.5 cm	Pork chops (MORE setting only)	245 g	1.5 cm	Lamb loin chops	110-140 g	1.5 cm				
Type of Meat	Approx. Weight	Approx. thickness																		
T-bone steak	240-380 g	1.5 cm																		
Rump steak	250 g	2-2.5 cm																		
Pork chops (MORE setting only)	245 g	1.5 cm																		
Lamb loin chops	110-140 g	1.5 cm																		
6	<b>Biscuits</b> Recommended biscuits; anzac chocolate chip apricot wheatgerm crunchies See recipes on page 12	1-2 layers (1 layer, approx. 200-250 g)	+20°C Room temperature	Preheat CONV.	<ul style="list-style-type: none"> <li>Preheat is automatic for this menu.</li> <li>ADD BISCUITS AFTER PREHEATING.</li> <li>Place biscuits on a small pizza tray.</li> <li>Bake on low rack. If cooking more than one layer, place one tray on turntable and second tray on high rack.</li> <li>After cooking, allow to cool slightly, remove from trays and place on wire rack.</li> </ul>															

# MULTI COOK MENU GUIDE

When you cook the following menus with MULTI COOK, press the MULTI COOK pad and the number pad of the menu.

The final cooking result will vary according to the food condition (e.g. initial temperature, shape, quality). Check the food after cooking and if necessary continue cooking manually.

No.	Menu	Weight Range	Initial Temperature (approx.)	Cooking Method	Procedure	Standing Time (minutes)																		
1	<b>Roast Beef</b> * You can select desired cooking result. MORE - Well done STD - Medium LESS - Rare	0.5-3.0 kg	+3°C Refrigerated	HIGH MIX	<ul style="list-style-type: none"> <li>Tie meat with string.</li> <li>Place fat side down on low rack.</li> <li>When oven stops and <input type="text" value="TURN"/> <input type="text" value="BEEF"/> <input type="text" value="OVER"/> is displayed, turn beef over.</li> <li>After cooking, stand, covered with aluminium foil.</li> </ul>	5-15																		
2	<b>Roast Lamb</b> * You can select desired cooking result. MORE - Well done STD - Medium	0.5-3.0 kg	+3°C Refrigerated	HIGH MIX	<ul style="list-style-type: none"> <li>Place fat side down on low rack.</li> <li>When oven stops and <input type="text" value="TURN"/> <input type="text" value="LAMB"/> <input type="text" value="OVER"/> is displayed, turn lamb over.</li> <li>After cooking, stand, covered with aluminium foil.</li> </ul>	5-15																		
3	<b>Roast Chicken</b>  Preparation before cooking <ul style="list-style-type: none"> <li>Remove neck and excess fat from chicken.</li> <li>Wash and dry chicken.</li> <li>Tie legs together.</li> </ul>	1.0-2.5 kg	+3°C Refrigerated	Preheat HIGH MIX	<ul style="list-style-type: none"> <li>Preheat is automatic for this menu.</li> <li>ADD CHICKEN AFTER PREHEATING.</li> <li>Place breast side down on low rack.</li> <li>When oven stops and <input type="text" value="TURN"/> <input type="text" value="CHICKEN"/> <input type="text" value="OVER"/> is displayed, turn chicken over.</li> <li>After cooking, stand, covered with aluminium foil.</li> </ul>	5-15																		
4	<b>Roast Dinner</b> MORE - Well done STD - Medium  Variety of meat-beef/lamb Variety of vegetables-potato/pumpkin	0.5-2.5 kg (weight of meat)	+3°C Refrigerated	HIGH MIX CONV.	<ul style="list-style-type: none"> <li>For best results we recommend to parboil potatoes prior to cooking. See NOTE below.</li> <li>Place seasoned meat directly on the greased turntable.</li> <li>While meat is cooking, prepare vegetables and place on a flat pizza tray.</li> <li>When oven stops and <input type="text" value="TURN"/> <input type="text" value="MEAT"/> <input type="text" value="OVER"/> <input type="text" value="ADD"/> <input type="text" value="VEGE-"/> <input type="text" value="TABLETS"/> is displayed, if necessary drain off the fat, turn meat over and add vegetables over the meat using high rack.</li> <li>After cooking, stand meat, covered with aluminium foil.</li> </ul> <p>If you prefer the vegetables a little crisper, while the meat is standing, place the vegetables back into the oven and cook for 12-15 mins. on convection 250°C.</p> <table border="1"> <thead> <tr> <th>Meat weight</th> <th>Vegetable weight</th> <th>Serves</th> </tr> </thead> <tbody> <tr> <td>2.5 kg</td> <td>1.5 kg</td> <td>6</td> </tr> <tr> <td>2.0 kg</td> <td>1.25 kg</td> <td>4-5</td> </tr> <tr> <td>1.5 kg</td> <td>1.0 kg</td> <td>4</td> </tr> <tr> <td>1.0 kg</td> <td>0.75 kg</td> <td>2-3</td> </tr> <tr> <td>0.5 kg</td> <td>0.4 kg</td> <td>2</td> </tr> </tbody> </table>	Meat weight	Vegetable weight	Serves	2.5 kg	1.5 kg	6	2.0 kg	1.25 kg	4-5	1.5 kg	1.0 kg	4	1.0 kg	0.75 kg	2-3	0.5 kg	0.4 kg	2	5-15
Meat weight	Vegetable weight	Serves																						
2.5 kg	1.5 kg	6																						
2.0 kg	1.25 kg	4-5																						
1.5 kg	1.0 kg	4																						
1.0 kg	0.75 kg	2-3																						
0.5 kg	0.4 kg	2																						

NOTE : To parboil potatoes prior to roasting.  
1. Place potatoes into a Pyrex® bowl.  
2. Cover with 2-3 cups hot tap water.



3. Cover with a lid or plastic wrap.  
4. Cook for 8-12 minutes on HIGH, until tender but firm. Drain well.



# REHEAT SENSOR MENU GUIDE

1. Dinner Plate
2. Soup
3. Casseroles/Canned Food

This feature is designed to give best results for the foods listed in the chart below.  
To reheat other foods, refer to your Sharp Cook Book.

Menu	 Weight Range	 Initial Temperature (approx.)	Cooking Method	Procedure	 Standing Time (minutes)								
<b>Dinner Plate</b>	1 serve (approx. 400 g)	+3°C Refrigerated	MICRO	<ul style="list-style-type: none"> <li>• Cover with plastic wrap.</li> <li>• Place on the low rack.</li> <li>• After cooking, stand covered.</li> </ul>	2								
	<table border="1"> <thead> <tr> <th>MEAT</th> <th>POTATO</th> <th>VEGETABLES</th> </tr> </thead> <tbody> <tr> <td>175-180g</td> <td>125g</td> <td>100g</td> </tr> <tr> <td>Beef, Lamb Chicken, T-Bone</td> <td>sliced</td> <td>2 varieties eg. sliced Carrot, Zucchini Broccoli</td> </tr> </tbody> </table>	MEAT	POTATO	VEGETABLES	175-180g	125g	100g	Beef, Lamb Chicken, T-Bone	sliced	2 varieties eg. sliced Carrot, Zucchini Broccoli			
MEAT	POTATO	VEGETABLES											
175-180g	125g	100g											
Beef, Lamb Chicken, T-Bone	sliced	2 varieties eg. sliced Carrot, Zucchini Broccoli											
<b>Soup</b>	1-4 cups (1 cup, 250 ml)	+20°C Room temperature	MICRO	<ul style="list-style-type: none"> <li>• Place in a Pyrex bowl.</li> <li>• Cover with plastic wrap.</li> <li>• After cooking, stand covered and stir.</li> </ul>	2-3								
For other beverages, see HINT below.													
<b>Casseroles</b> Beef Stroganoff Springtime Lamb Apricot Chicken	1-4 cups (1 cup, 250 ml)	+3°C Refrigerated	MICRO	<ul style="list-style-type: none"> <li>• Place into a casserole dish, and cover with lid.</li> <li>• Place on the low rack.</li> <li>• After cooking, stir and stand covered.</li> </ul>	1-5								
<b>Canned Food</b> Baked Beans Spaghetti		+20°C Room temperature											

## HINT

### To Reheat Beverage

Tea, Coffee, Water(+20°C Room Temperature)

Qty(250 ml per 1 cup)	Cooking Time	Power Level
1 cup	1 1/2 minutes	HIGH
2 cups	2 1/2 minutes	HIGH

\*Stir after heating.

## DESSERTS

### *Apple Crunch*

Serve	2-4 serves	4-6 serves	6-8 serves
Ingredients;			
can pie apples	400 g	600 g	800 g
White Wings butter cake mix	1/2 cup	3/4 cup	1 1/2 cups
butter, cut into thin slices	50 g	75 g	150 g
brown sugar	1 tbs	2 tbs	3 tbs
coconut	1 tbs	2 tbs	3 tbs
crushed nuts	1 tbs	2 tbs	3 tbs
cinnamon	1/2 ts	1 ts	1 ts

1. Place pie apple in a shallow dish.
2. Sprinkle evenly with dry cake mix.
3. Layer sliced butter over cake mix.
4. Combine brown sugar, coconut, nuts and cinnamon. Sprinkle over crunch.
5. Press the Sensor Instant Action pad for Desserts.
6. After cooking, stand 3-5 mins.

### *Chocolate Self-Saucing Pudding*

Serve	2-4 serves	4-6 serves	6-8 serves
Ingredients;			
Self-Raising Flour	1/2 cup	3/4 cup	1 1/4 cups
cocoa powder	1 tbs	2 tbs	3 tbs
caster sugar	1/4 cup	1/3 cup	1/2 cup
milk	1/4 cup	1/2 cup	3/4 cup
dark cooking chocolate, melted	50 g	100 g	150 g
butter, melted	30 g	60 g	90 g
brown sugar	1/2 cup	3/4 cup	1 1/4 cups
cocoa, extra	1 tbs	2 tbs	3 tbs
boiling water	1 cup	1 1/2 cups	2 1/2 cups

1. Combine flour, cocoa, caster sugar in a pudding bowl.  
Stir in milk, chocolate and butter. Mix until smooth.
2. In a separate bowl, mix brown sugar, extra cocoa powder and boiling water together.  
Pour over mixture.
3. Press the Sensor Instant Action pad for Desserts.
4. After cooking, stand 3-5 mins.

### *Muesli Custard Delight*

Serve	2-4 serves	4-6 serves	6-8 serves
Ingredients;			
sour cream	3/4 x 300 g carton	300 g carton	300 g carton
can sliced peaches, drained	425 g can	825 g can	3 x 425 g can
White Wings butter cake mix	1/2 cup	1 cup	1 cup
toasted muesli	3/4 cup	1 1/2 cups	2 cups
coconut	2 tbs	1/4 cup	1/2 cup
butter, melted	75 g	125 g	175 g

1. Spread sour cream evenly over base of pie plate. Sprinkle with drained peaches.
2. Combine butter cake mix, muesli, coconut and butter. Mix well.
3. Spread muesli mixture peaches.
4. Press the Sensor Instant Action pad for Desserts.
5. After cooking, stand 3-5 mins.

# Sensor Instant Action Recipes

## CASSEROLES

### Beef Stroganoff

Serves	1 serve	2 serves	3 serves	4 serves	
Ingredients;	rump steak, cubed	250 g	500 g	750 g	1 kg
	plain flour	2 tbs	¼ cup	⅓ cup	½ cup
	salt and pepper	to taste	to taste	to taste	to taste
	onion, chopped	½ (small)	1 (small)	1	1
	tomato puree	2 ts	1 tbs	1½ tbs	2 tbs
	beef stock	125 ml	200 ml	250 ml	375 ml
	red wine	60 ml	60 ml	60 ml	60 ml
	mushroom, thinly sliced	25 g	50 g	75 g	100 g
	sour cream	75 ml	150 ml	200 ml	300 ml

1. Toss steak with flour, salt and pepper in a freezer bag until evenly coated.
2. Place steak, left over flour, onion, tomato puree, beef stock and wine into a casserole dish.
3. Cover with a glass lid and press the Sensor Instant Action pad for Casseroles.

#### 4. For small quantity

The oven will stop and display   at this stage stir the casserole and add mushrooms. Cover with lid. Press Start pad to continue cooking.

#### For large quantity

The oven will stop and display . At this stage stir the casserole. Cover with lid and press Start pad to continue cooking.

The oven will stop again and display  , at this stage stir the casserole and add mushrooms. Cover with lid. Press Start pad to continue cooking.

5. After cooking stir in sour cream and stand, covered 2–5 minutes. Serve hot with boiled rice or pasta.

### Springtime Lamb Casserole

Serves	1 serve	2 serves	3 serves	4 serves	
Ingredients;	lamb, cubed	250 g	500 g	750 g	1 kg
	French onion soup mix	2 tbs	4 tbs	1 pkt	1 pkt
	plain flour	2 tbs	4 tbs	¼ cup	¼ cup
	spring onion, chopped	1	2	3	4
	small carrot, sliced	1	2	2	2
	chicken stock	½ cup	½ cup	¾ cup	1 cup
	corn kernels	60 g	125 g	310 g	310 g
	celery	1 stick	1 stick	2 sticks	2 sticks
	sour cream	75 ml	150 ml	200 ml	300 ml

1. Toss lamb in combined French onion soup mix and flour in a freezer bag until evenly coated.
2. Place lamb left over flour, onion, carrot and chicken stock in a casserole dish.
3. Cover with a glass lid and press the Sensor Instant Action pad for Casseroles.

#### 4. For small quantity

The oven will stop and display   at this stage stir the casserole, add the corn and celery. Cover with lid. Press Start pad to continue cooking.

#### For large quantity

The oven will stop and display . At this stage stir the casserole. Cover with lid and press Start pad to continue cooking.

The oven will stop again and display   at this stage stir the casserole, add the corn and celery. Cover with lid. Press Start pad to continue cooking.

5. After cooking, stir in sour cream and stand, covered 2–5 minutes before serving.

### Apricot Chicken

Serves	1 serve	2 serves	3 serves	4 serves	
Ingredients;	chicken breast fillets, cubed	250 g	500 g	750 g	1000 g
	flour	1 tbs	1½ tbs	2 tbs	2 tbs
	French onion soup mix	2 tbs	3 tbs	1 pkt	2 pkts
	apricot nectar	125 ml	250 ml	375 ml	500 ml
	dried apricot, halved	100 g	200 g	300 g	400 g

1. Toss chicken in combined French onion soup mix and plain flour.
2. Place into a casserole dish and cover with a glass lid.
3. Press the Sensor Instant Action pad for Casseroles.

#### 4. For small quantity

The oven will stop and display   at this stage stir the casserole and add apricot nectar and apricots. Cover with lid. Press Start pad to continue cooking.

#### For large quantity



The oven will stop and display , at this stage stir the casserole. Cover with lid. Press Start pad to continue cooking. The oven will stop again and display

, at this stage add apricot nectar and apricots. Cover with lid. Press Start pad to continue cooking.





5. After cooking, stir and stand, covered 2–5 minutes before serving.

# SENSOR INSTANT ACTION MENU GUIDE

The final cooking result will vary according to the food condition (e.g. initial temperature, shape, quality). Check the food after cooking and if necessary continue cooking manually.

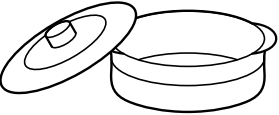
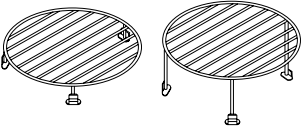
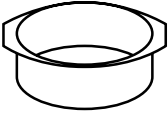
Menu	 Weight Range	 Initial Temperature (approx.)	Cooking Method	Procedure	 Standing Time (minutes)
<b>Fresh Vegetables</b> Carrots } Potato } hard vegetables Beans } Brussels Sprouts } Broccoli } medium vegetables Cauliflower } Zucchini } Spinach } soft vegetables Cabbage } Squash }	0.1-1.0 kg	+20°C Room temperature	MICRO	<ul style="list-style-type: none"> <li>Wash the vegetables.</li> <li>Pierce skin of squash with fork.</li> <li>Arrange the vegetables in a shallow dish in the following way : hard vegetables around the outside, soft vegetables in the centre, medium vegetables in-between.</li> <li>Cover with a glass lid or plastic wrap.</li> <li>After cooking, stand covered and stir.</li> </ul>	1-5
<b>Reheat Pie</b> includes : Pies Pasties	1-6 pieces (1 piece, approx. 160-200g)	+3°C Refrigerated	MICRO HIGH MIX	<ul style="list-style-type: none"> <li>Place pie upside down on the low rack on the turntable.</li> <li>When oven stops and <b>TURN</b> <b>PIES</b> <b>OVER</b> is displayed, turn over pies and continue cooking.</li> <li>After cooking, stand.</li> </ul>	1-3
<b>Jacket Potato</b> Potato (whole)	1-10 pieces (1 piece, approx. 150g)	+20°C Room temperature	MICRO	<ul style="list-style-type: none"> <li>Use washed new potatoes.</li> <li>Pierce twice with fork on each side.</li> <li>Place on outside of turntable.</li> <li>When oven stops and <b>TURN</b> <b>POTATO</b> <b>OVER</b> is displayed, turn over potatoes and continue cooking.</li> <li>After cooking, stand, covered with aluminium foil.</li> </ul>	3-10
<b>Frozen Vegetables</b> Carrots } Beans } hard vegetables Brussels Sprouts } Broccoli } medium vegetables Cauliflower } Corn } soft vegetables Green Peas } Mixed Vegetables }	0.1-1.0 kg	-18°C Frozen	MICRO	<ul style="list-style-type: none"> <li>Before cooking, separate vegetables eg. broccoli as much as possible.</li> <li>Arrange the vegetables in a shallow dish in the following way : hard vegetables around the outside, soft vegetables in the centre, medium vegetables in-between.</li> <li>Cover with a glass lid or plastic wrap.</li> <li>After cooking, stand covered and stir.</li> </ul>	1-5
<b>Casseroles</b>	1-4 serves		MICRO HIGH MIX	<ul style="list-style-type: none"> <li>See recipes on page ⑦.</li> </ul>	
<b>Desserts</b>	2-8 serves		MICRO LOW MIX	<ul style="list-style-type: none"> <li>See recipes on page ⑧.</li> </ul>	

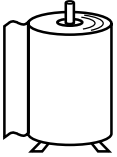
# COOKWARE & UTENSIL GUIDE

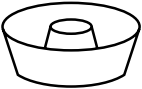
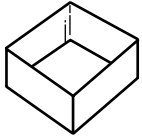
		MICROWAVE	CONVECTION	MIX COOKING	GRILL	
 OVENPROOF GLASS	 METAL RACKS	<b>METAL RACKS</b>	YES (LOW RACK ONLY)	YES	YES	YES
		<b>GLASSWARE/CERAMIC (HEAT RESISTANT)</b>	YES	YES	YES	YES
 CAKE TIN	 PIZZA TRAY	<b>METAL COOKWARE</b>	NO	YES	<sup>*1</sup> YES	YES
		<b>OVEN BAGS</b>	YES	YES	YES	NO
 PAPER TOWEL	 FOIL	<b>ALUMINIUM FOIL</b>	For Shielding	YES	For Shielding	YES
		<b>NON-STICK PAPER</b>	YES	YES	YES	NO
 RING CENTRE DISH	 SQUARE DISH	<b>GREASE-PROOF PAPER</b>	YES	YES	YES	NO
		<b>WAXED PAPER</b>	YES	NO	NO	NO
		<b>PLASTIC WRAP</b>	<sup>*2</sup> YES	NO	NO	NO
		<b>PAPER TOWEL</b>	YES	NO	NO	NO
		<b>PLASTIC COOKWARE MICROWAVE SAFE</b>	<sup>*3</sup> YES	NO	NO	NO
		<b>BROWNING DISH</b>	YES	NO	NO	NO
		<b>DEFROST RACK</b>	Defrost Only	NO	NO	NO
		<b>THERMOMETERS MICROWAVE SAFE</b>	YES	NO	NO	NO
		<b>CONVENTIONAL</b>	NO	YES	NO	NO

<sup>\*1</sup> When using metal utensil, place a heat resistant dish between the metal utensil and the rack (refer to page ③).

<sup>\*2</sup> For cooking food with high fat contents, do not bring the wrap in contact with the food as it may melt.

<sup>\*3</sup> Some microwave safe plastic cookware are not suitable for cooking foods with high fat and sugar content.

# HELPFUL HINTS

## GRILLING

1. Use thick oven gloves when removing food or the turntable from the oven to **PREVENT BURNS**. Because accessible parts (e.g. oven door, oven cavity, dishes and accessories) will become hot when in use.
2. Preheat is automatic for this menu.  
Add food after pre-heating.
3. Place food on the high rack in the oven after preheating. (Round pizza trays may be used if necessary).

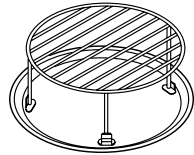

HIGH RACK & TURNTABLE

When grilling food that cause excessive fat splatter and smoke (eg. steak, chops) the following principles should be followed:

- \* Remove turntable from the oven before preheating.
- \* Fit the high rack on the turntable, place the food on the rack and pour 1/2 cup of tap water on the turntable. (Otherwise the dripping fat drops onto the hot turntable causing the smoke).
- \* The turntable should be fitted in the oven after preheating.

4. The oven is preset at 250°C, this can be reduced to accommodate a variety of foods.
5. If you are cooking and wish to check the temperature you have programmed, simply press the CONVEC pad. The programmed temperature will be displayed as long as CONVEC pad is pressed.

# HELPFUL HINTS

## CONVECTION COOKING

1. Use thick oven gloves when removing food or the turntable from the oven to PREVENT BURNS. Because accessible parts (e.g. oven door, oven cavity, dishes and accessories) will become hot when in use.
2. Can be used the same a conventional oven.
3. When cooking your own recipes; cook for a slightly shorter cooking time, at the temperature the recipe suggests. Then add additional time if necessary.
4. For best results, preheat to required temperature with the turntable in the oven. Add food after preheating.
5. Foods may be cooked either directly on turntable, or using the high or low racks.
6. Do not cover turntable, high rack, or low rack with aluminium foil.

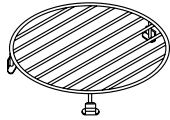

LOW RACK

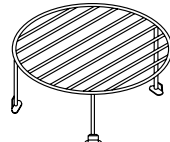

HIGH RACK

7. Metal cookware can be used. Round pizza trays are excellent cooking utensils for cooking.

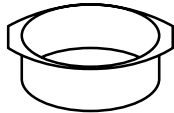

CAKE TIN

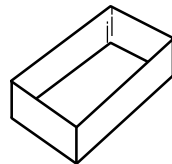

SQUARE DISH



PIZZA TRAY

8. If you are cooking and wish to check the temperature you have programmed, simply press the CONVEC pad. The programmed temperature will be displayed as long as CONVEC pad is pressed.
9. Use convection cooking for baking delicate foods or those which have short cooking times. ie. biscuits, scones, choux pastry or pavlova.

## MIX COOKING

1. There are two automatic, pre-programmed mix settings.
  - a) Low Mix - Convection 180°C with 10% microwave power. Use for baking cakes, slices, bread, quiches, pastries.
  - b) High Mix - Convection 200°C with 30% microwave power. Use for roasting meats, lasagne and meat loaf.
2. Use thick oven gloves when removing food or the turntable from the oven to PREVENT BURNS. Because accessible parts (e.g. oven door, oven cavity, dishes and accessories) will become hot when in use.
3. The convection temperature can be changed to accommodate all your favorite recipes.

4. Metal cookware can be used. During mix cooking some metal utensils may cause arcing when they come in contact with oven walls or accessory racks. To prevent arcing when using a metal tin, place a heat resistant dish (Pyrex® pie plate, dinner plate) between the tin and the rack.

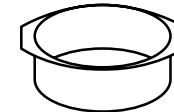

CAKE TIN

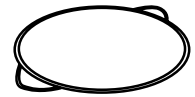

PIZZA TRAY

5. If you are cooking and wish to check the temperature you have programmed simply press the CONVEC pad. The programmed temperature will be displayed as long as CONVEC pad is pressed.
6. When converting conventional recipes the following principles should be followed:
  - \* When using High Mix cut the time by two-thirds: use half the normal cooking time when using Low Mix.
  - \* Cut the temperature by 10% from conventional recipe temperatures.
  - \* Use the low rack whenever possible.
  - \* When baking, preheat the oven as you would normally.

# HELPFUL HINTS

## MICROWAVE COOKING

### 1. ARRANGEMENT

Arrange foods carefully. Place thickest areas toward outside of dish.

Eg. Arrange vegetables in a shallow dish in the following way:

Hard Vegetables around the outside, Soft Vegetables in the centre, Medium Vegetables in-between.



### 2. TURNING

Foods such as poultry and joints of meat should be turned over after half the cooking time.

### 3. COVERING

Cover foods in the microwave if you would normally cover the food in your ordinary oven, or to retain moisture. Cover foods such as Vegetables, Casseroles, or when Reheating.

Use to cover foods:

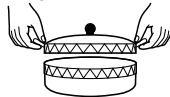

LID



PLASTIC WRAP

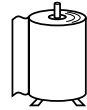

PAPERTOWEL

### 4. PIERCING

Pierce potatoes, eggs, oysters, tomatoes or any foods with a skin or membrane to allow steam to escape.



TOMATO



EGG

### 5. SHIELDING

Shield using small pieces of aluminium foil to shield thin areas of meat, fish and poultry or edges of cakes to prevent overcooking.



FISH



CHICKEN

### 6. STANDING TIME

Standing time is important. After cooking or defrosting ensure adequate standing time. This allows the food to continue cooking or heating. Refer to cooking guides for each menu or according to manufacturers instructions.

### 7. STIRRING

Stir foods from the outside to the centre of the dish, once or twice during cooking if possible.

Eg. Casseroles and Sauces.



STIR

### 8. SIZE

Small pieces cook faster than large ones. To speed cooking, cut pieces smaller than 5 cm so microwaves can penetrate to the centre from all sides. For even cooking, make all the pieces the same size.

### 9. DENSITY

The depth to which microwaves penetrate food varies depending on the food's density. Porous foods like minced beef or mashed potatoes microwave faster than dense ones like steak or whole potatoes.

### 10. FAT AND BONE

Marbling within meat, or a thin, even layer of fat on a roast, speeds cooking. Large fatty areas or excess drippings in dish attract energy away from meat, and slows cooking. Centre bones do not affect cooking, but bone on the side of meat conducts heat to the areas next to it.

### 11. STARTING TEMPERATURE

Frozen or refrigerated food takes longer to heat than food at room temperature. Cooking times in this book are based on normal storage temperatures. Since rooms, refrigerators and freezers differ in temperature, check for doneness at the minimum time.



### 12. QUANTITY

Microwave cooking times are directly related to the amount of food in the oven. Because energy is absorbed by the food itself, one potato or a single piece of chicken cooks rapidly. When the energy is divided among several items, cooking takes more time.

### 13. CONDENSATION

Condensation is a normal part of microwave cooking. The humidity and moisture in food will influence the amount of condensation in the oven. Generally, covered foods will not cause as much condensation as uncovered foods. Ensure that the ventilation openings are not blocked.

### 14. GENERAL

Your microwave oven is capable of heating food and beverages very quickly therefore, it is very important that you select the appropriate cooking time and power level for the type and quantity of food to be heated. If you are unsure of the cooking time and power level required, begin with low cooking times and power levels until the food is sufficiently heated evenly throughout.



FEATURE	QUICK OPERATION GUIDE	
Sensor Instant Action	<b>JACKET POTATO</b>	PRESS Once to automatically cook 1 to 10 potatoes.
Reheat Sensor	<b>REHEAT SENSOR</b> → <b>INSTANT COOK START</b>	PRESS REHEAT SENSOR Once for DINNER PLATE Twice for SOUP Three times for CASSEROLES/CANNED FOOD
Multi Cook	<b>MULTI COOK</b> → Menu Number <b>1</b> → Weight <b>1</b> <b>0</b> → <b>INSTANT COOK START</b>	eg. No.1 eg. 1.0kg
Easy Defrost	<b>EASY DEFROST</b> → Weight <b>1</b> <b>0</b> → <b>INSTANT COOK START</b>	eg. 1.0kg
Variable Cooking Control	To soften Cream Cheese or Butter for 40 seconds on M•LOW. Cooking Time <b>4</b> <b>0</b> → <b>POWER LEVEL</b> x 4 → <b>INSTANT COOK START</b>	
Preheat	<b>PREHEAT</b> → Temp <b>5</b> <b>160°C</b> → <b>INSTANT COOK START</b>	eg. 160°C
Manual Convection Cooking	<b>CONVEC</b> → Temp <b>6</b> <b>180°C</b> → Cooking Time <b>1</b> <b>5</b> <b>0</b> <b>0</b> → <b>INSTANT COOK START</b>	eg. 180°C eg. 15 minutes
Mix Cooking	<b>HIGH MIX</b> → Cooking Time <b>1</b> <b>5</b> <b>0</b> <b>0</b> → <b>INSTANT COOK START</b>	eg. 15 minutes
Grill Cooking	<b>GRILL</b> → Cooking Time <b>1</b> <b>5</b> <b>0</b> <b>0</b> → <b>INSTANT COOK START</b>	eg. 15 minutes

## CONTENTS COOKING GUIDE

QUICK REFERENCE GUIDE ①	HELPFUL HINTS ② - ④	COOKWARE AND UTENSIL GUIDE ⑤	SENSOR INSTANT ACTION MENU GUIDE ⑥ - ⑧	REHEAT SENSOR MENU GUIDE ⑨	MULTI COOK MENU GUIDE ⑩ - ⑫	EASY DEFROST MENU GUIDE ⑬
-------------------------	---------------------	------------------------------	--	----------------------------	-----------------------------	---------------------------